

**196.7050 | Two Output Shower W/ Rain Head & Hand Held**

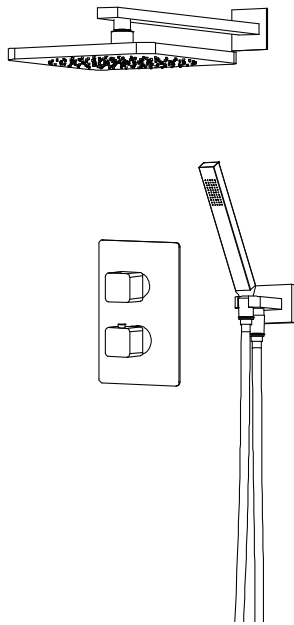

**COMPONENTS**

- HS1050 - 15" Shower Arm
- HSB.10C - 10" Shower Head
- 196.4000T - Shower Trim
- TVH.4420F - Shower Valve
- HS1003 - Hand Held Set

**SHOWER VALVE:**

- Thermostatic shower valve
- Valve includes service stops
- Turn bottom handle to set temp.
- Top handle controls water diversion
- Includes 15109 non-shared cartridge

**SHOWER HEAD:**

- Solid brass construction
- 1.8 GPM flow rate

**STANDARDS:**

- ASME A112.18.1 / CSA B125.1

See individual component specification sheets on following pages for further details.

HS1050 | Square Shower Arm - 15"

SPECIFICATIONS:

- Solid Brass Shower Arm
- With Fixed Flange

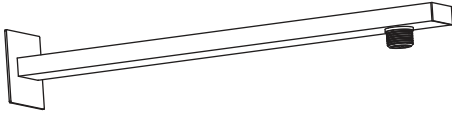

Technical Diagram

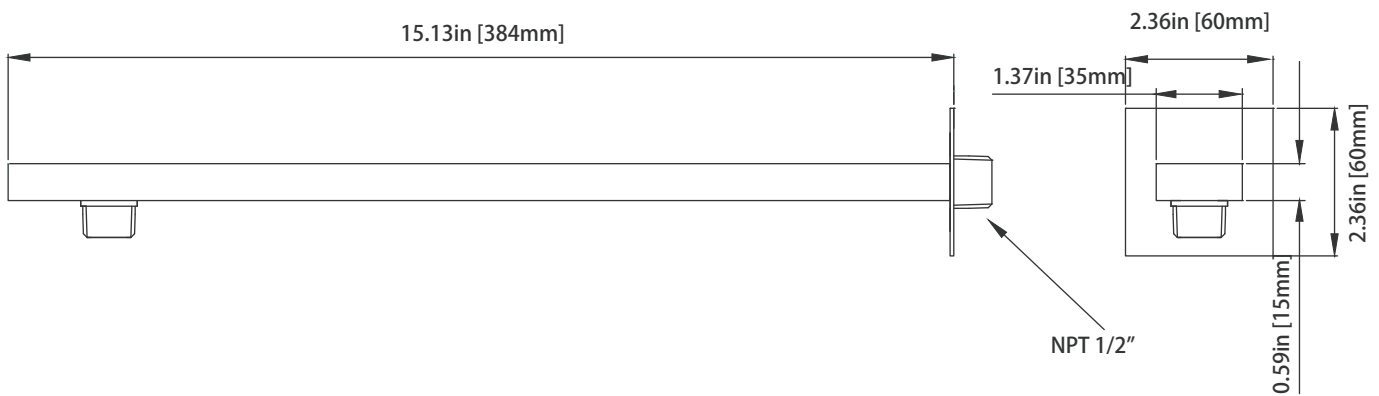

HSB.10C | 10" Brass Shower Head

SPECIFICATIONS:

- Solid Brass Shower Head
- Scrub rubber nozzles to easily clean water sediment
- 1.8 GPM Flow Rate
- 200 Nozzles
- Use with HS1050 Shower Arm

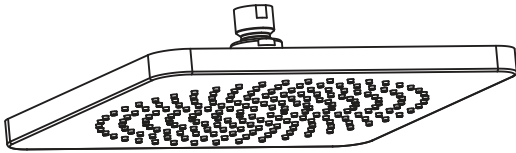

Technical Diagram

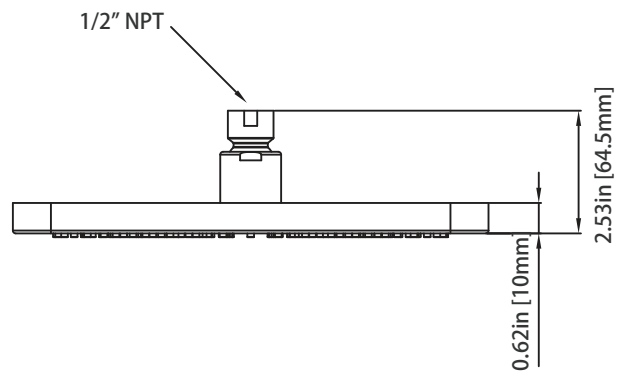
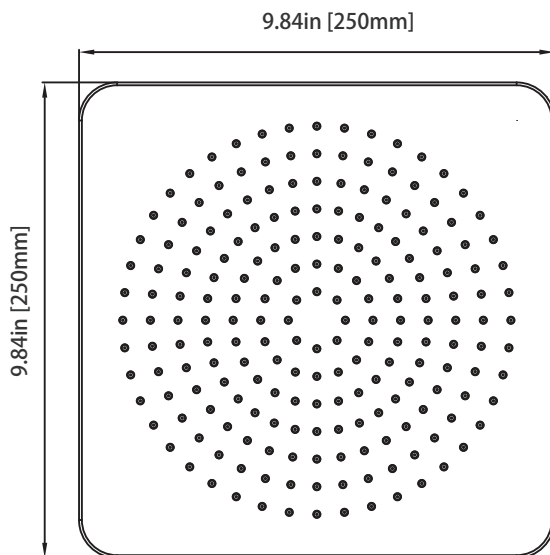

**196.4000T | Thermostatic Shower Trim**

**SPECIFICATIONS:**

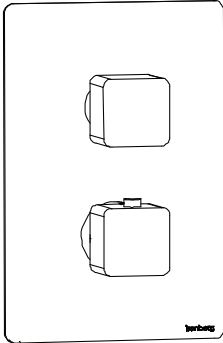

- Solid Brass construction
- Valve not included - trim only
- Turn bottom handle to control temperature.
- Turn top handle to divert water & control volume
- Extension Available - TVH.4101E\*\*

**Technical Diagram**

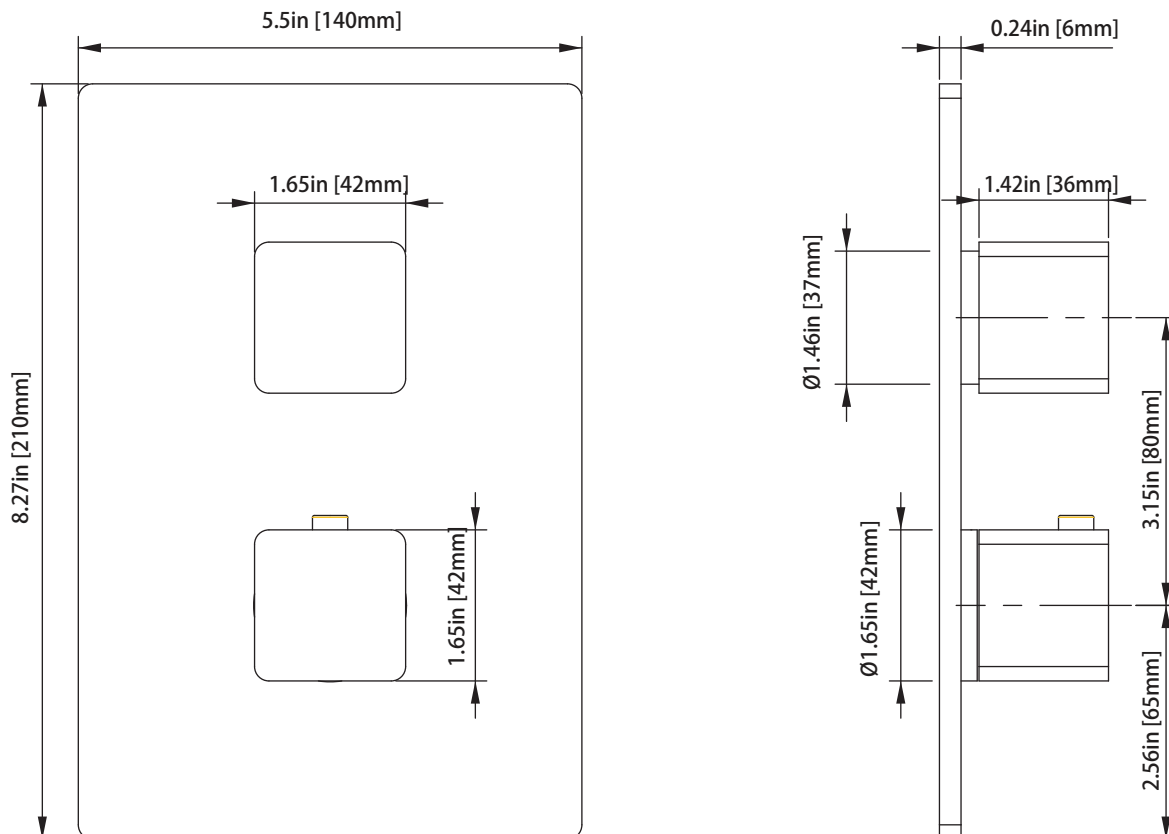

TVH.4420F | 3/4" Thermostatic Valve With 2-Way Diverter & Integrated Volume Control Page 2 of 2

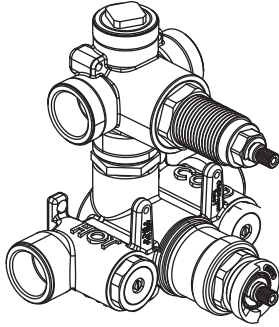

**SPECIFICATIONS:**

- Turn bottom knob to control temperature.
- Turn top knob to control water flow.
- Thermostatic Valve Flow Rate - 8.0 GPM @ 60 PSI
- Extension Available - TVH.4101E\*\*

**STANDARDS:**

- ASME A112.18.1 / CSA B125.1

**!** A separate volume control is **not** needed to turn water supply off. Volume control functionality is integrated within this valve.

**Technical Diagram**

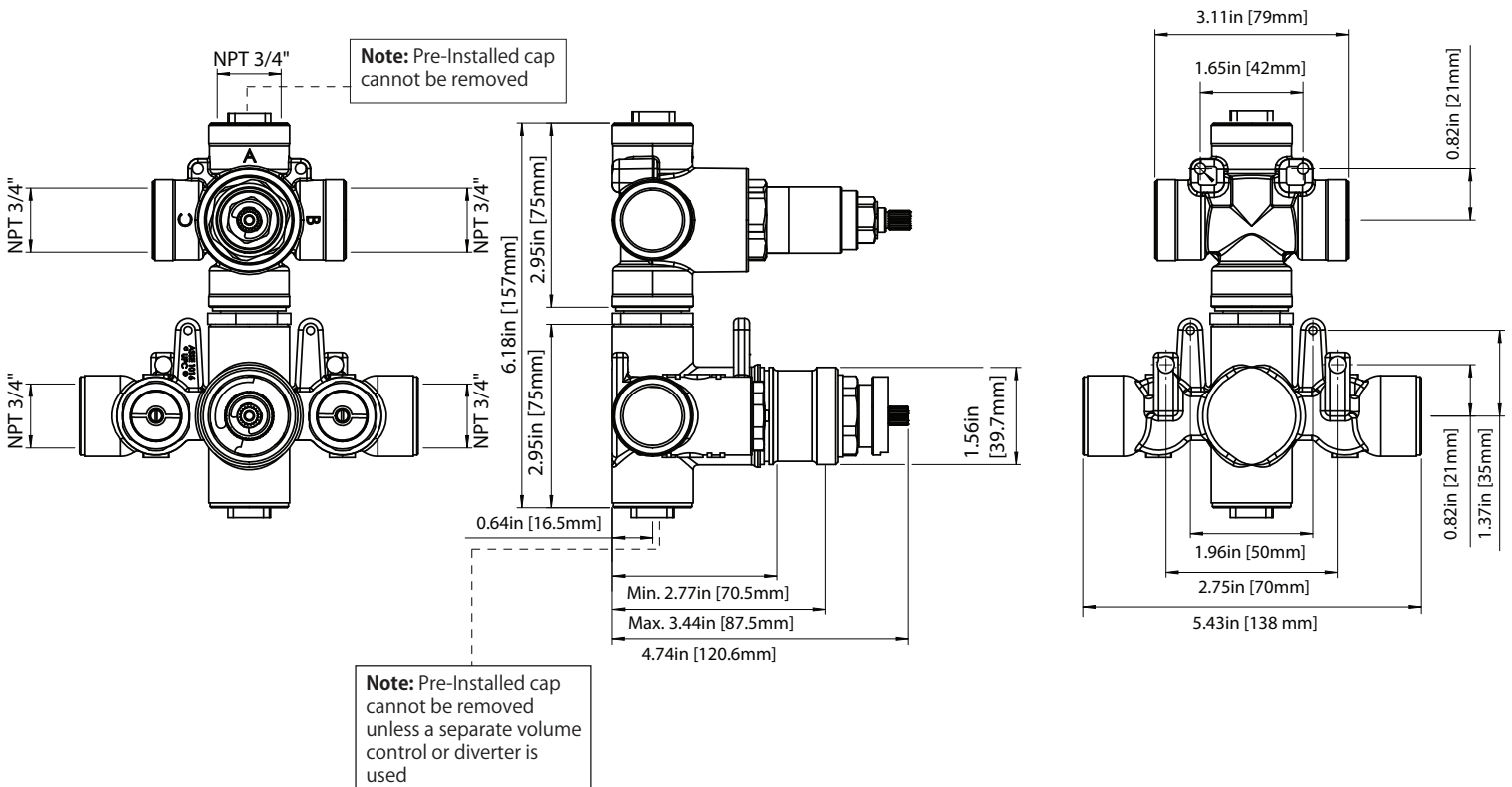

**TVH.4420F | 3/4" Thermostatic Valve With 2-Way Diverter & Integrated Volume Control** Page 2 of 2



**TWO OUTPUT - CAL-GREEN - NO SHARED PORT OPERATION**

Diverter Cartridge # - **15109** (Included)

Total 3 Positions as defined below, with **only** 1 port active at one time.

- Position 0 - Off - No Water Flow
- Position 1 - Output B Activated
- Position 2 - Output C Activated

**TWO OUTPUT - SHARED PORT OPERATION**

Diverter Cartridge # - **15103** (Not Included)

Total 4 Positions as defined below, with 2 ports active at one time.

- Position 0 - Off - No Water Flow
- Position 1 - Output B Activated
- Position 2 - Output B+C Activated
- Position 3 - Output C Activated

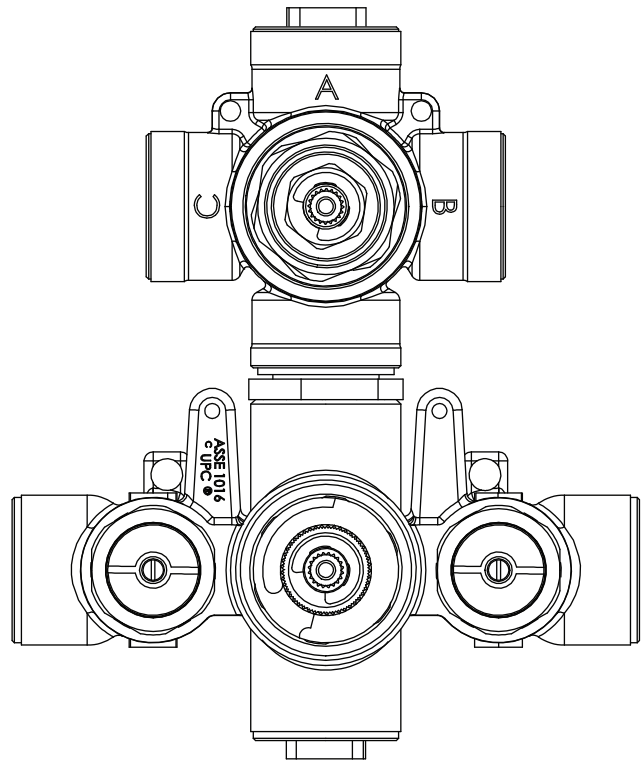

**Water Diversion Diagram**

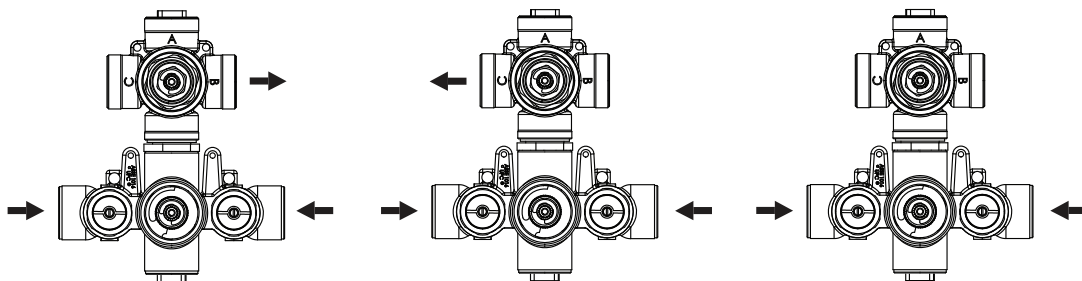

Diverter Position = 1

Diverter Position = 2

Diverter Position = off

**HS1003 | Solid Brass Hand Shower Set**

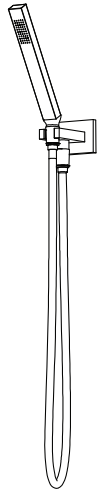

**SPECIFICATIONS:**

- Solid Brass construction
- Single function hand held
- 1/2" female elbow connection
- Includes check valve with back-flow prevention
- 1.8 GPM Flow Rate

**Technical Diagram**

