

196.7000 | Single Output Shower W/ Rain Head

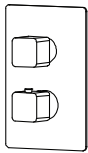

**COMPONENTS**

- HS1050 - 15" Shower Arm
- HSB.10C - 10" Shower Head
- 196.4101T - Shower Trim
- TVH.4101 - 3/4" Shower Valve

**SHOWER VALVE:**

- Thermostatic shower valve
- Valve includes service stops
- Turn bottom handle to set temp.
- Top handle controls water volume

**SHOWER HEAD:**

- Solid brass construction
- 1.8 GPM flow rate

**STANDARDS:**

- ASME A112.18.1 / CSA B125.1

See individual component specification sheets on following pages for further details.

HS1050 | Square Shower Arm - 15"

SPECIFICATIONS:

- Solid Brass Shower Arm
- With Fixed Flange

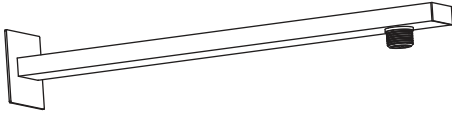

Technical Diagram

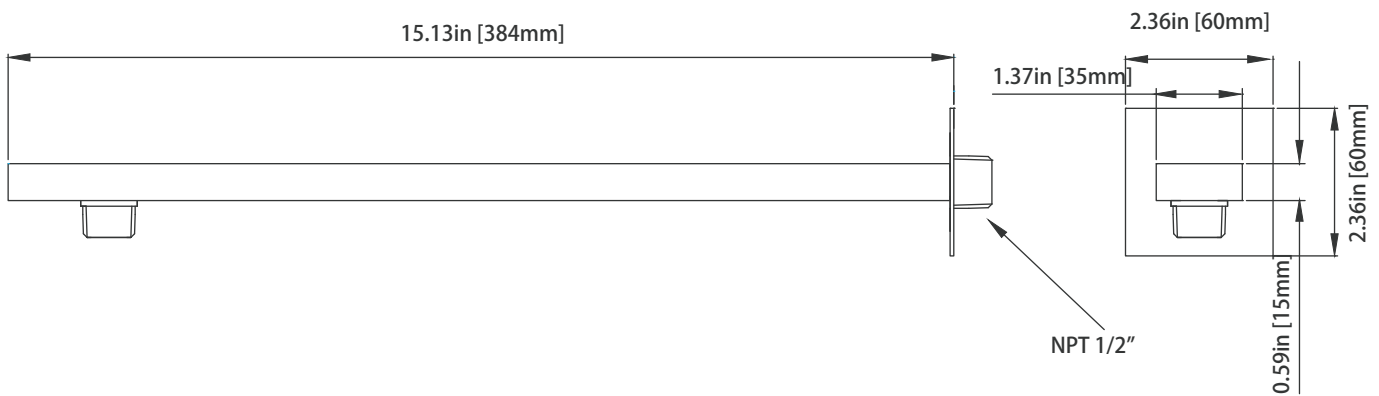

HSB.10C | 10" Brass Shower Head

SPECIFICATIONS:

- Solid Brass Shower Head
- Scrub rubber nozzles to easily clean water sediment
- 1.8 GPM Flow Rate
- 200 Nozzles
- Use with HS1050 Shower Arm

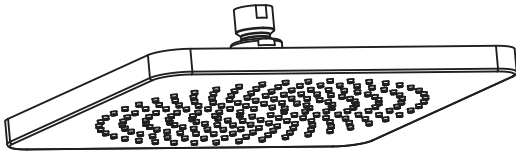

Technical Diagram

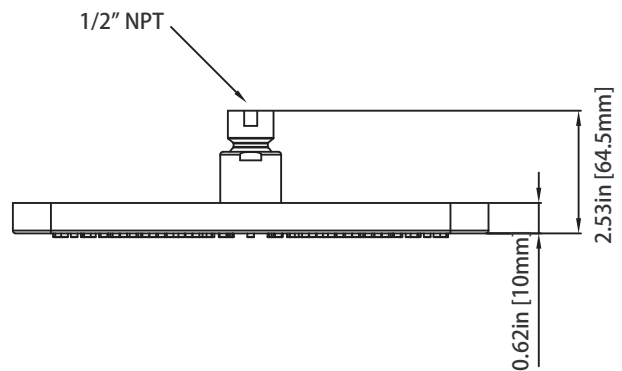
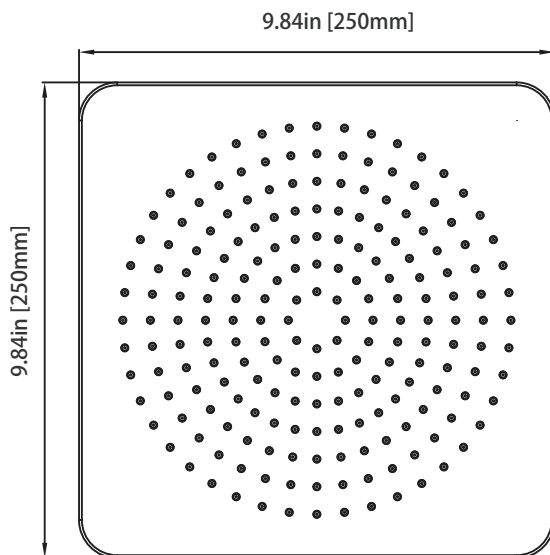

196.4000T | Thermostatic Shower Trim

SPECIFICATIONS:

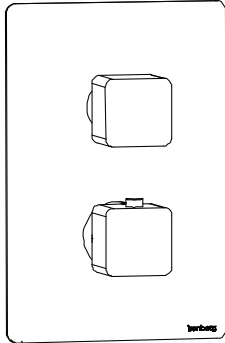

- Solid Brass construction
- Valve not included - trim only
- Turn bottom handle to control temperature.
- Turn top handle to divert water & control volume
- Extension Available - TVH.4101E\*\*

Technical Diagram

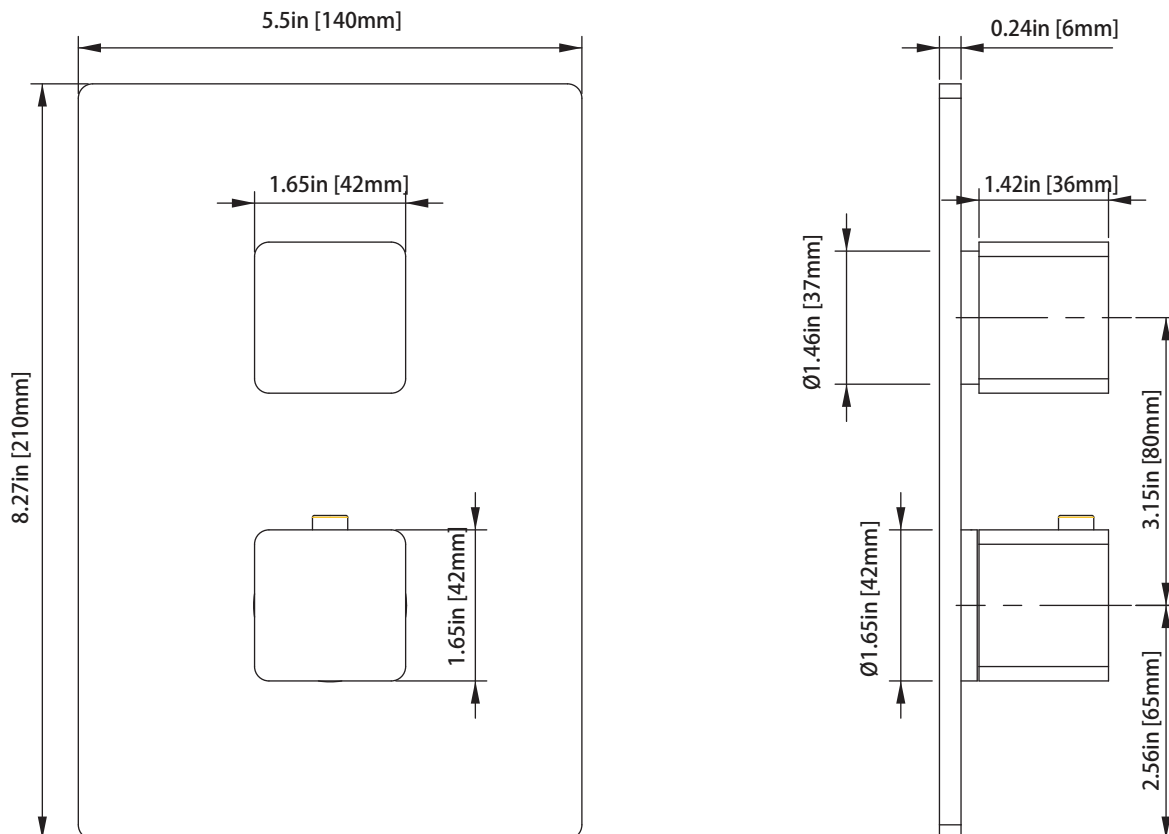

TVH.4101 | 3/4" Thermostatic Valve With Volume Control Page 1 of 2



**SPECIFICATIONS:**

- Turn bottom knob to control temperature.
- Turn top knob to control water flow.
- Thermostatic Valve Flow Rate - 13.0 GPM @ 60 PSI
- Extension Available - TVH.4101E\*\*

**STANDARDS:**

- ASME A112.18.1 / CSA B125.1

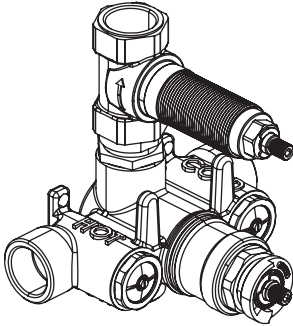

**Technical Diagram**

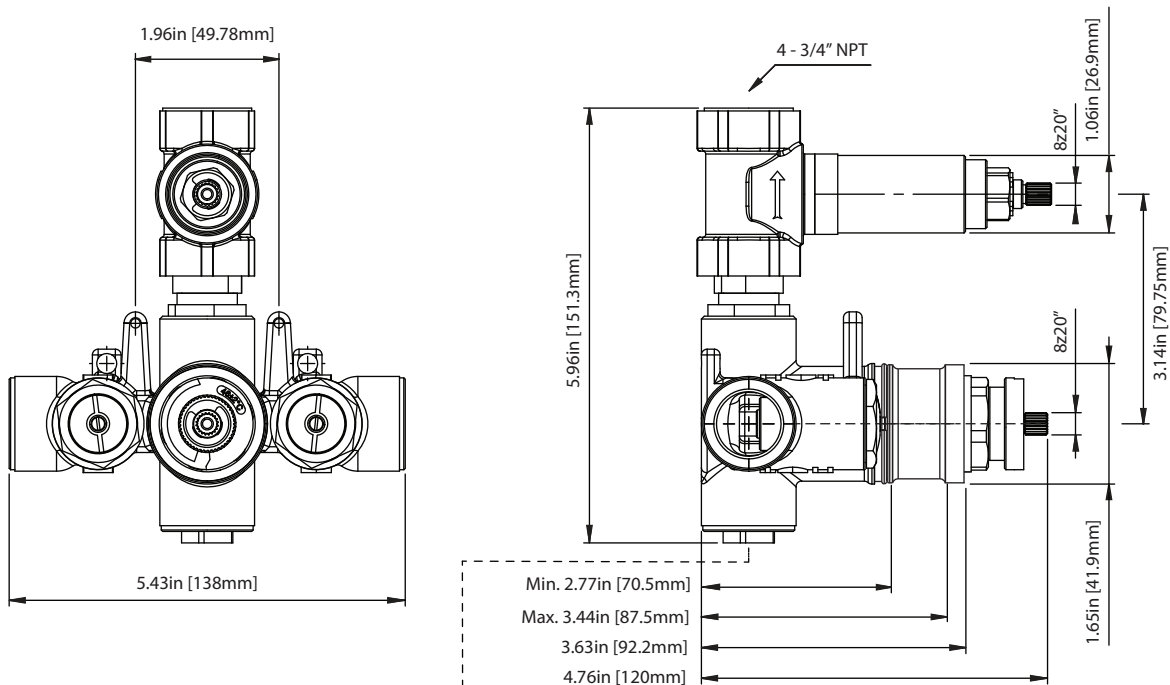

**Note:** Pre-Installed cap cannot be removed unless a separate volume control or diverter is purchased

TVH.4101 | 3/4" Thermostatic Valve With Volume Control Page 2 of 2



Water Flow Diagram

