

196.6410 | 1/2" Body Jet With Concealed Valve - Round



SPECIFICATIONS:

- 1.05 GPM Flow Rate @ 60 PSI
- Includes Concealed In-Wall Valve
- 20 Degree swivel directional angle

STANDARDS:

- ASME A112.18.1 / CSA B125.1

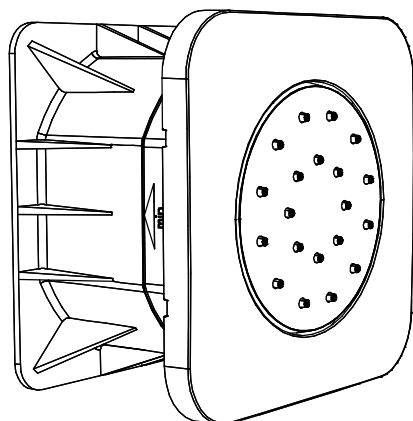

Technical Diagram

