

196.4101 | 3/4" Thermostatic Valve With Volume Control & Trim

SPECIFICATIONS:

- Turn bottom handle to control temperature.
- Turn top handle to control volume.
- Includes Thermostatic valve (TVH.4101) w/ service stops
- Thermostatic Valve Flow Rate - 13.0 GPM @ 60 PSI
- Extension Available - TVH.4101E**

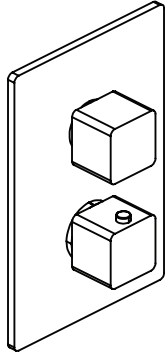

Trim
[196.4000T**]

+

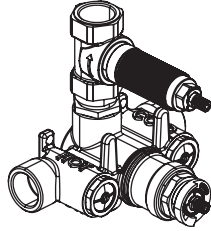

Valve
[TVH.4101]

See Spec Sheet For
TVH.4101 For Detailed
Information On Valve.

Technical Diagram

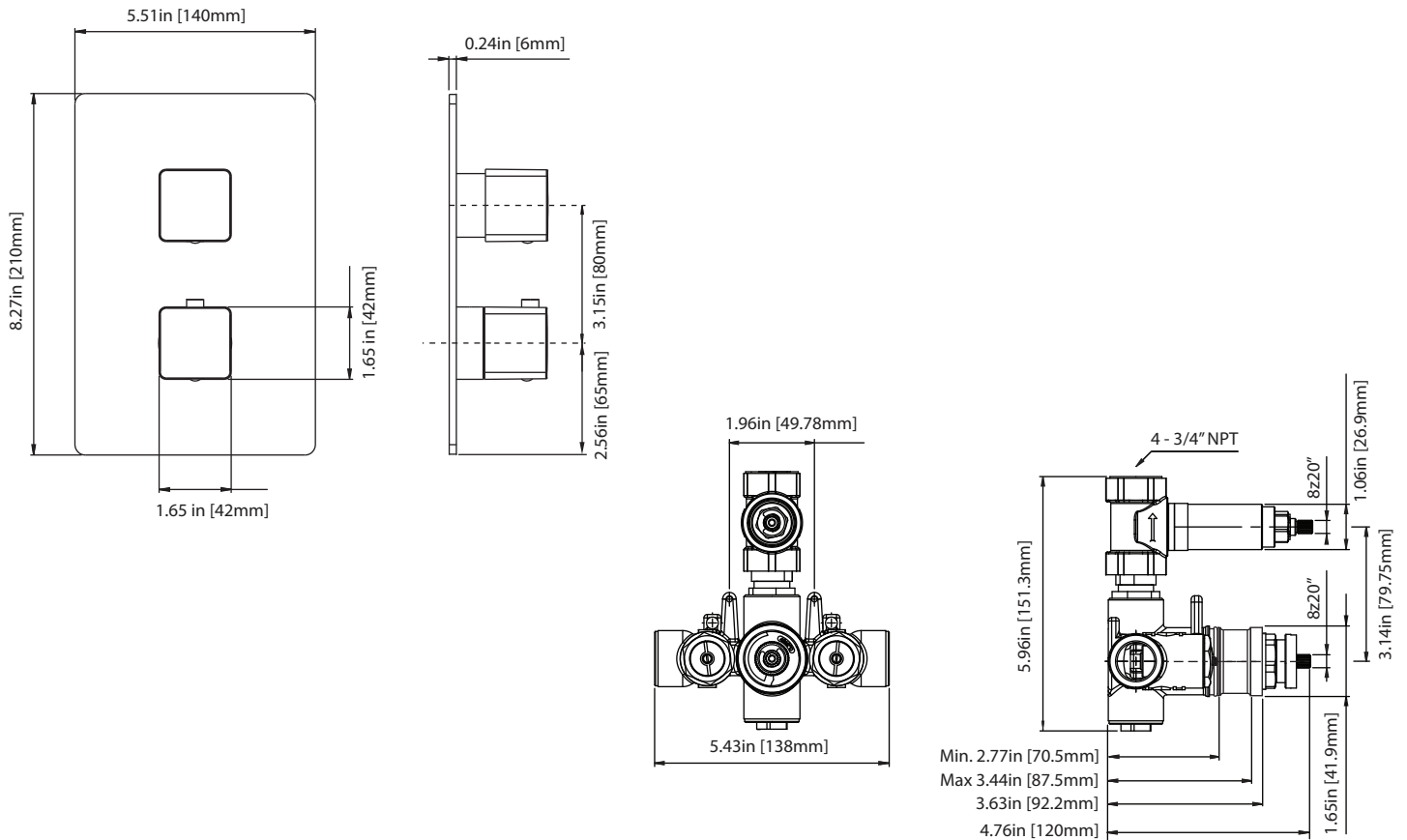

TVH.4101 | 3/4" Thermostatic Valve With Volume Control Page 1 of 2



SPECIFICATIONS:

- Turn bottom knob to control temperature.
- Turn top knob to control water flow.
- Thermostatic Valve Flow Rate - 13.0 GPM @ 60 PSI
- Extension Available - TVH.4101E**

STANDARDS:

- ASME A112.18.1 / CSA B125.1

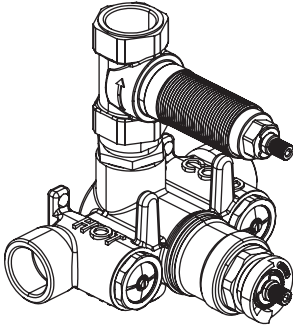

Technical Diagram

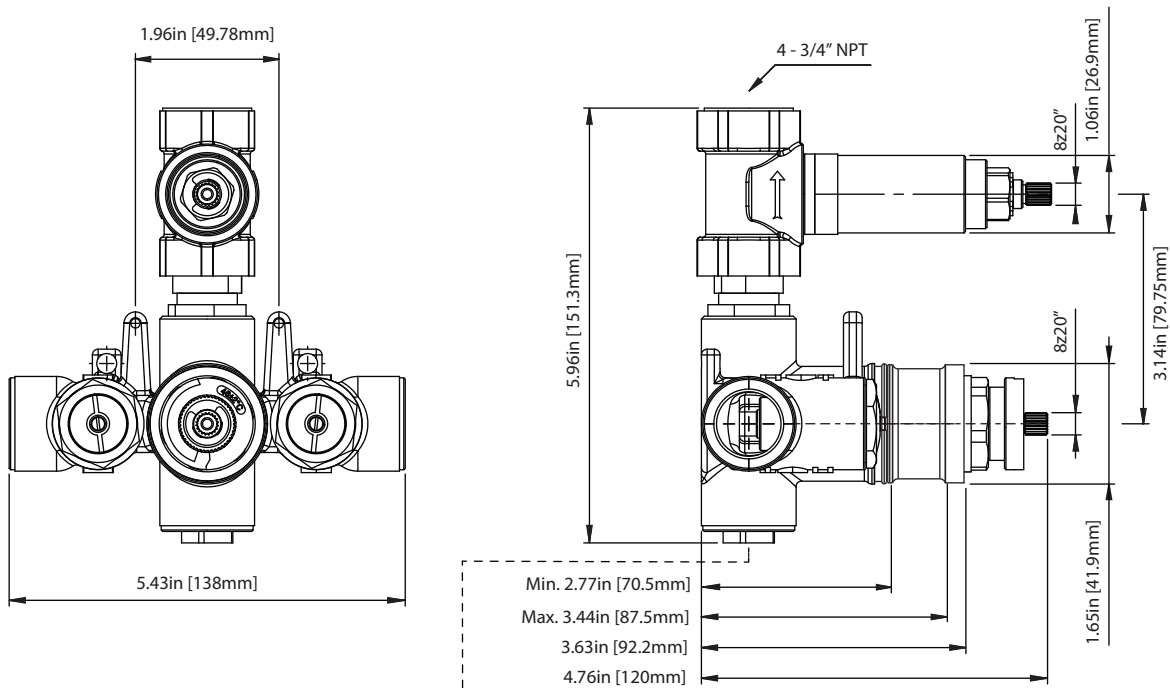

Note: Pre-Installed cap cannot be removed unless a separate volume control or diverter is purchased

TVH.4101 | 3/4" Thermostatic Valve With Volume Control Page 2 of 2



Water Flow Diagram

