

160.7000 | Single Output Shower W/ Rain Head

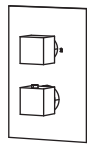
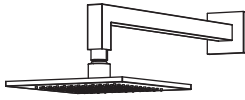

COMPONENTS

- HS1011SA - 16" Shower Arm
- HS1001A - 8" Shower Head
- 160.4000T - Shower Trim
- TVH.4101 - 3/4" Shower Valve

SHOWER VALVE:

- Thermostatic shower valve
- Valve includes service stops
- Turn bottom handle to set temp.
- Top handle controls water volume

SHOWER HEAD:

- Solid brass construction
- 1.8 GPM flow rate

HS1011SA | Square Shower Arm - 400mm - 16"

SPECIFICATIONS:

- Solid Brass Shower Arm
- With Sliding Flange

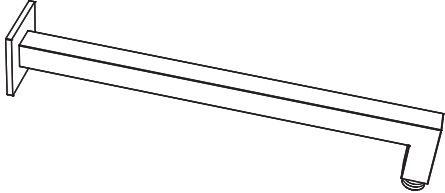

Technical Diagram

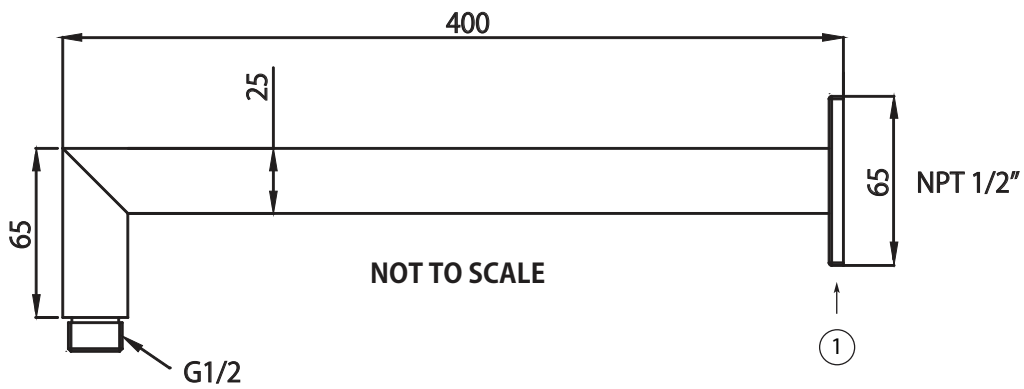

HS1001A | 8" Brass Shower Head



SPECIFICATIONS:

- Solid Brass Shower Head
- Scrub rubber nozzles to easily clean water sediment
- 1.8 GPM Flow Rate

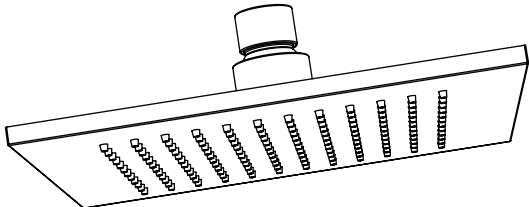

Technical Diagram

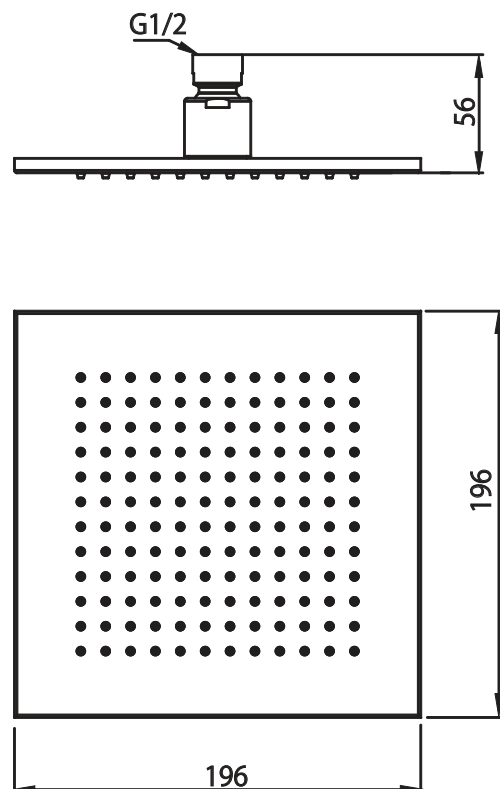

160.4000T | Thermostatic Shower Trim

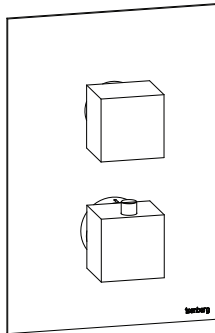

SPECIFICATIONS:

- Solid Brass construction
- Valve not included - trim only
- Turn bottom handle to control temperature.
- Turn top handle to divert water & control volume

Technical Diagram

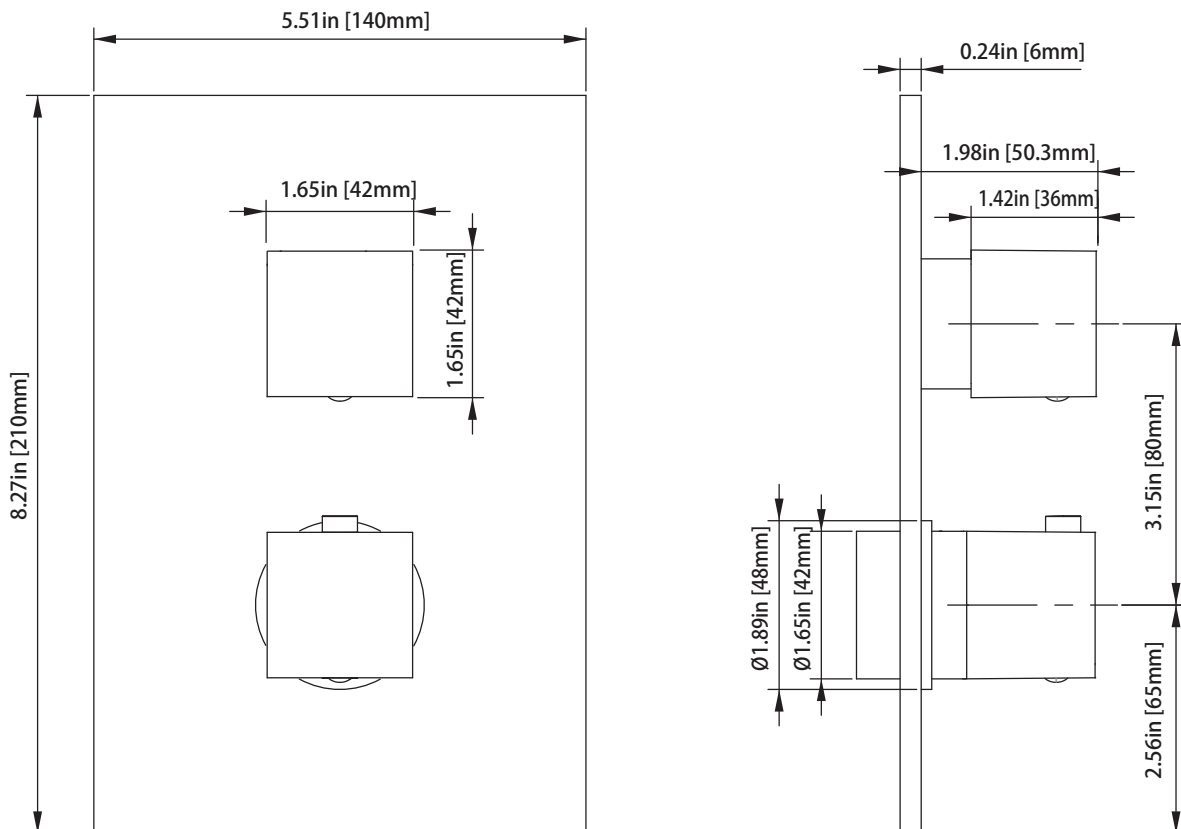

TVH.4101 | 3/4" Thermostatic Valve With Volume Control Page 1 of 2

SPECIFICATIONS:

- Turn bottom knob to control temperature.
- Turn top knob to control water flow.
- Thermostatic Valve Flow Rate - 13.0 GPM @ 60 PSI
- Extension Available - TVH.4101E**

STANDARDS:

- ASME A112.18.1 / CSA B125.1

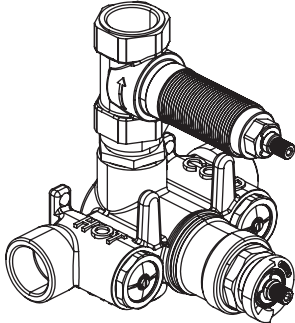

Technical Diagram

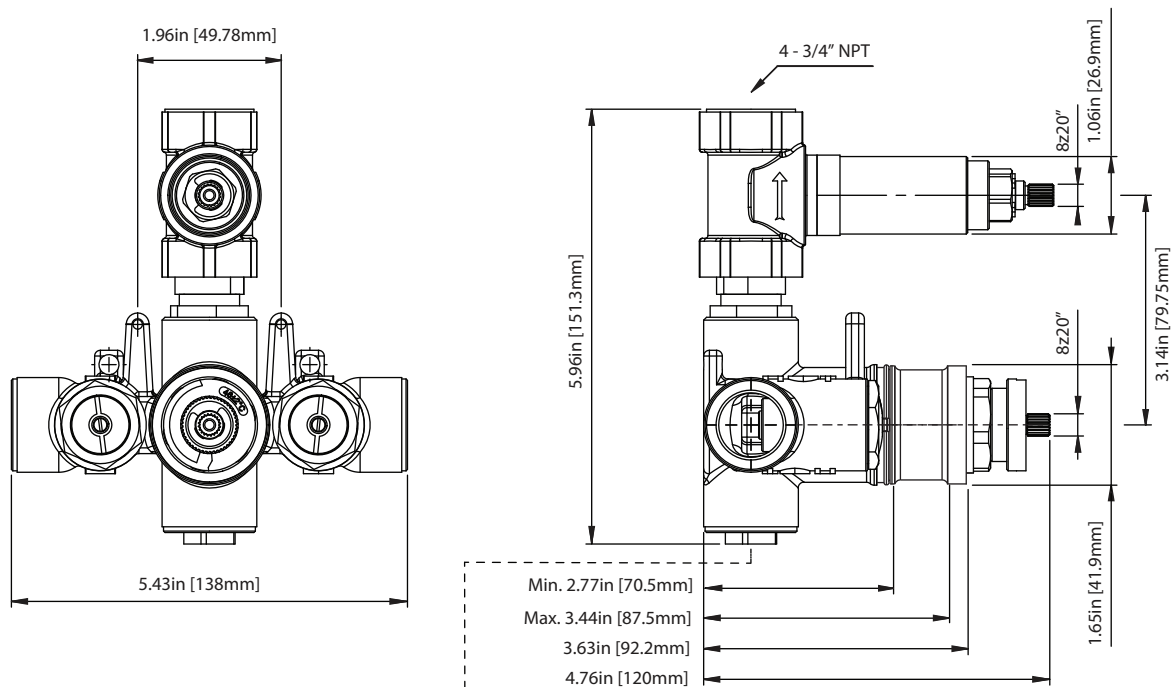

Note: Pre-Installed cap cannot be removed unless a separate volume control or diverter is purchased

TVH.4101 | 3/4" Thermostatic Valve With Volume Control Page 2 of 2



Water Flow Diagram

