

250.1950T | Three Hole Wall Mount Faucet - Trim Only

SPECIFICATIONS:

- Solid Brass construction
- Use with Valve (WLM.1900) - Not Included
- Three Hole Installation
- 1.2 GPM Flow Rate @ 60 PSI
- Extension Available - 250.1950E**

STANDARDS:

- ASME A112.18.1 / CSA B125.1, NSF-61

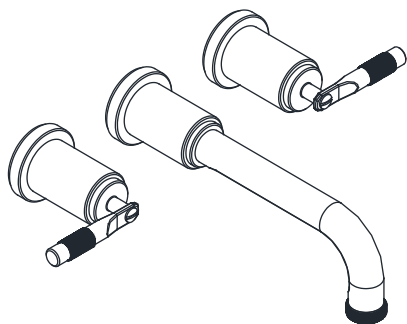

FLOW
Efficient

Technical Diagram

