

145.1000 | Single Hole Faucet

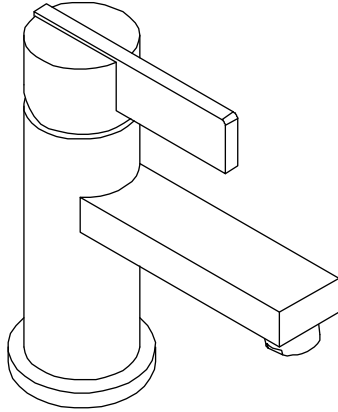

SPECIFICATIONS:

- Solid Brass construction
- Single Hole Installation
- 1.2GPM @ 60 PSI
- Ceramic disc cartridge allows both volume and temperature control



STANDARDS:

- ASME A112.18.1 / CSA B125.1, NSF-61

FLOW
Efficient

Technical Diagram

