

160.12CSA | Ceiling Mount Shower Arm - 12"

SPECIFICATIONS:

- Solid Brass Construction
- With Flange
- Also available in 2" (160.2CSA), 6" (160.6CSA), 8" (160.8CSA) and 16" (160.16CSA) Versions

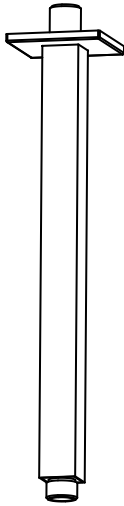

Technical Diagram

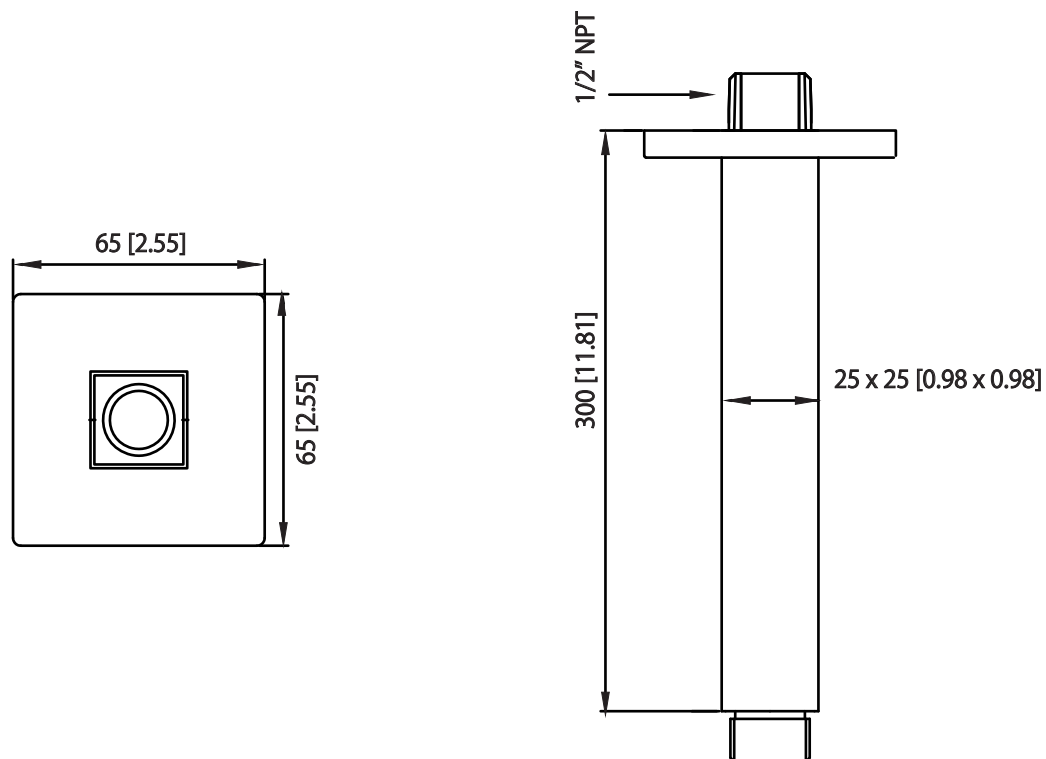

NOT TO SCALE