

260.7250 | Two Output Shower W/ Rain Head & Hand Held

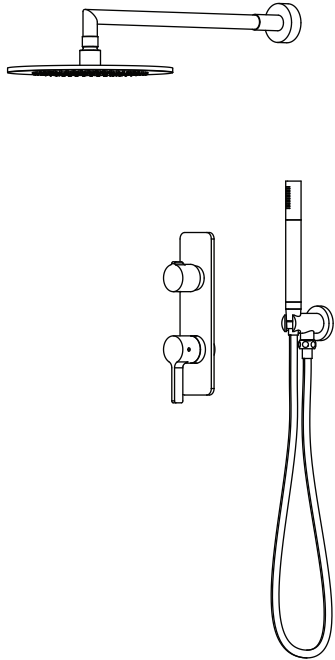

**COMPONENTS**

- HS1040 - 16" Shower Arm
- HSB.10R - 10" Shower Head
- 260.4000VT - Shower Trim
- TVH.2717F - 3/4" Shower Valve
- HS1004H - Hand Held
- HS8008 - Wall Elbow w/ Holder
- SP.150EM - 1.5m Hose

**SHOWER VALVE:**

- Thermostatic shower valve
- Valve includes service stops
- Turn bottom handle to set temp.
- Top handle controls water diversion
- Includes 15109 non-shared cartridge

**SHOWER HEAD:**

- Solid brass construction
- 1.8 GPM flow rate

**STANDARDS:**

- ASME A112.18.1 / CSA B125.1

See individual component specification sheets on following pages for further details.

HS1040 | Round Shower Arm - 400mm - 16"

SPECIFICATIONS:

- Solid Brass Shower Arm
- With Sliding Flange

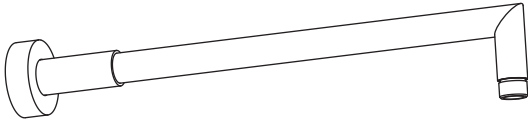

Technical Diagram

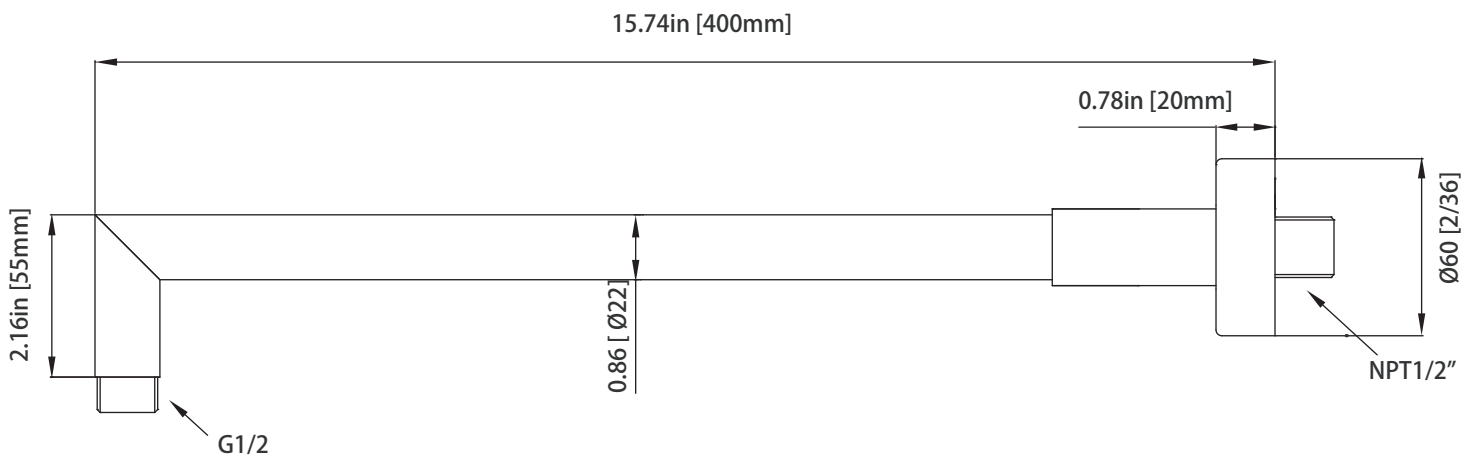

HSB.10R | 10" Brass Shower Head

SPECIFICATIONS:

- Solid Brass Shower Head
- Scrub rubber nozzles to easily clean water sediment
- 1.8 GPM Flow Rate
- 121 Nozzles

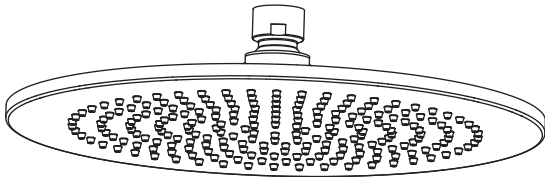

Technical Diagram

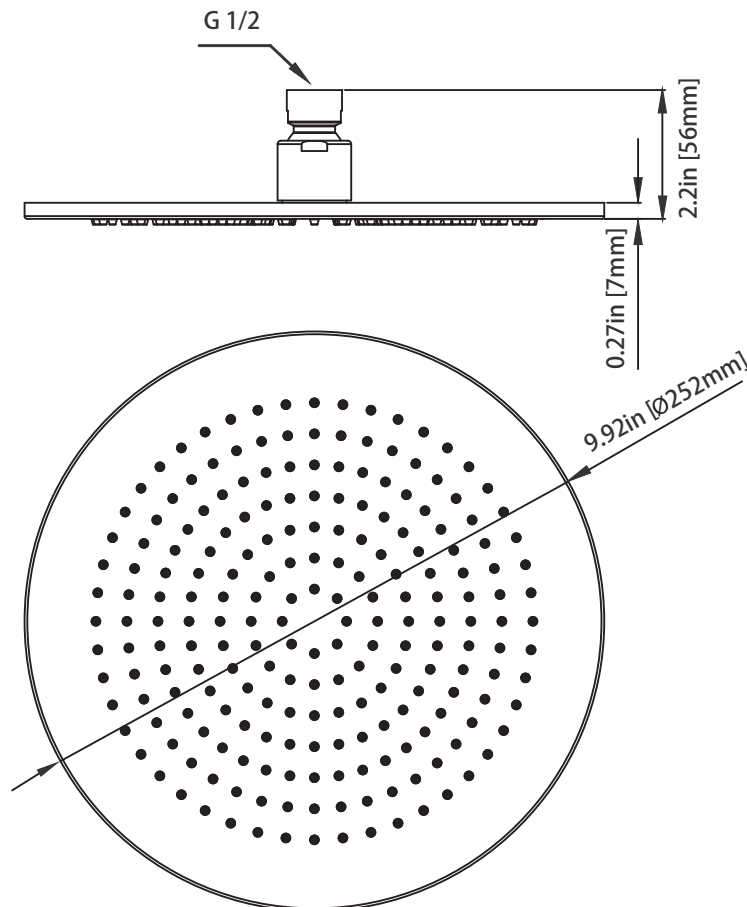

260.4000VT | Thermostatic Shower Trim

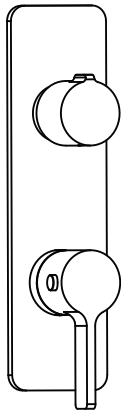

SPECIFICATIONS:

- Solid Brass construction
- Valve not included - Trim only
- Bottom knob controls temperature
- Top knob controls volume
- Use in tub filler or shower applications

Technical Diagram

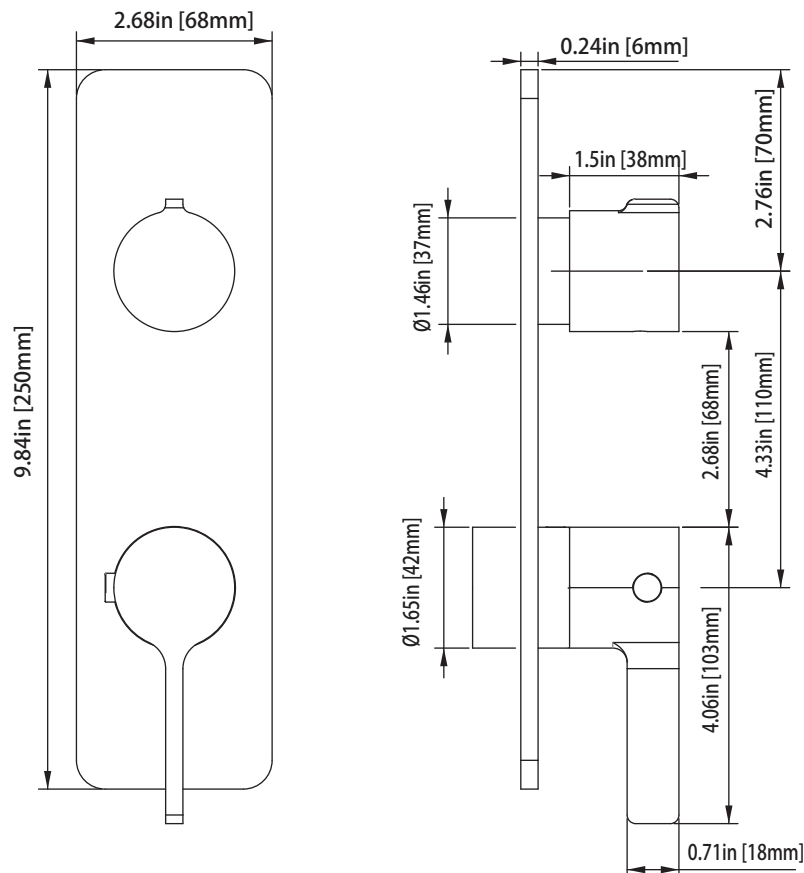

TVH.2717F | 3/4" Thermostatic Valve With 2-Way Diverter & Integrated Volume Control Page 1 of 2

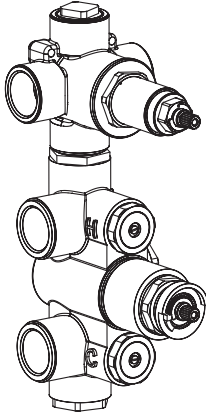

**SPECIFICATIONS:**

- Turn bottom knob to control temperature.
- Turn top knob to control water flow.
- Thermostatic Valve Flow Rate - 8.0 GPM @ 60 PSI
- Extension Available - TVH.4101E\*\*

**STANDARDS:**

- ASME A112.18.1 / CSA B125.1

**!** A separate volume control is **not** needed to turn water supply off. Volume control functionality is integrated within this valve.

**Technical Diagram**

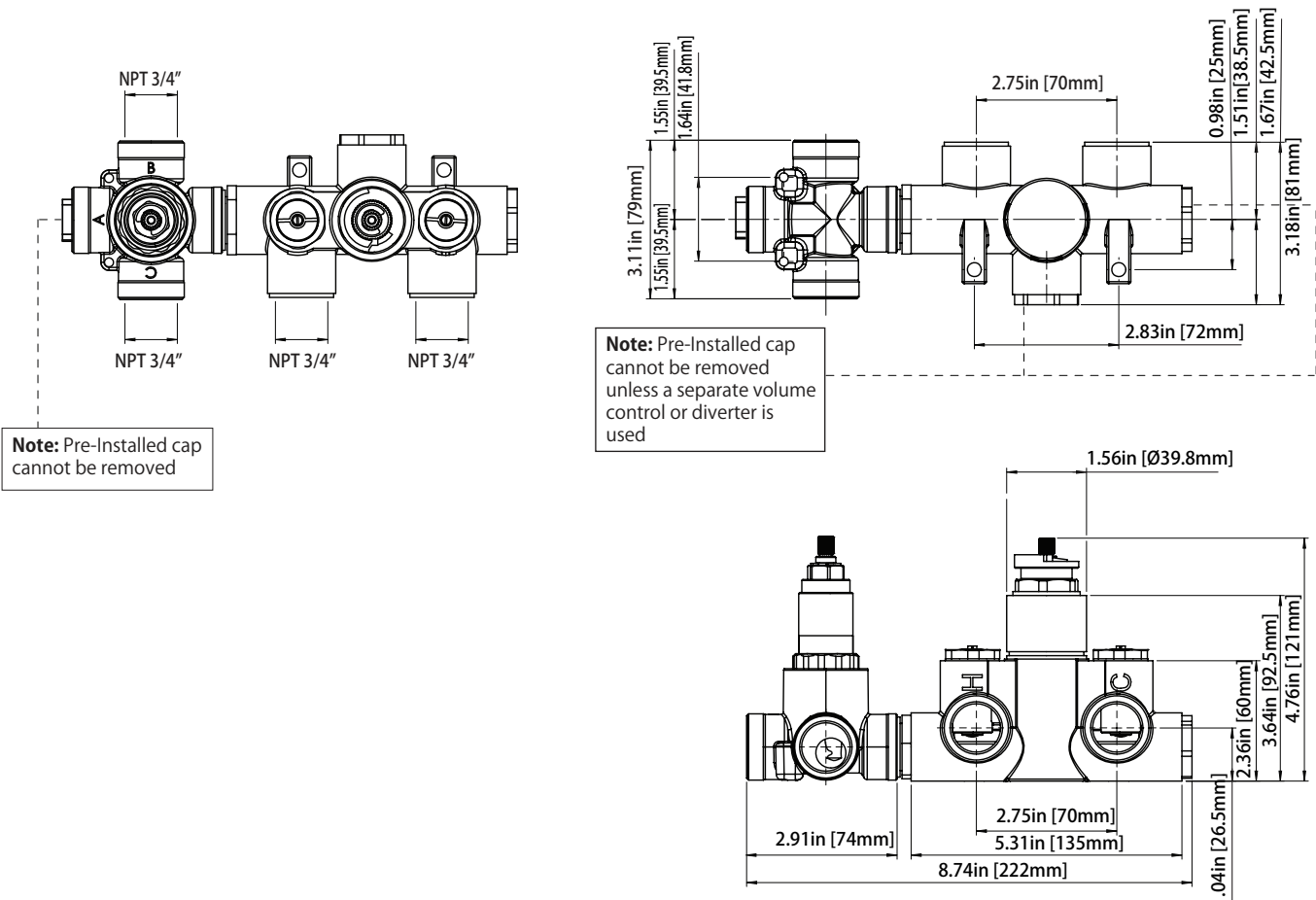

HS1004H | Solid Brass Hand Shower

SPECIFICATIONS:

- Solid Brass Construction
- 1.8 GPM Flow Rate
- With back flow prevention check valve



Technical Diagram

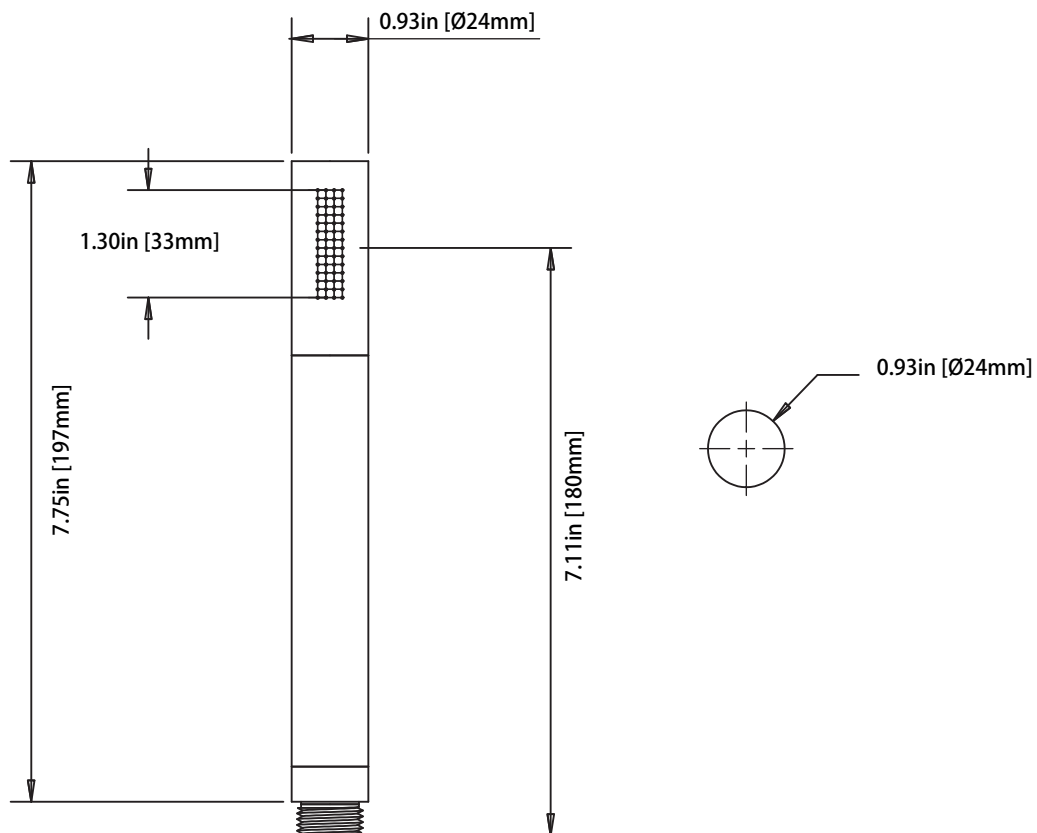

**HS8008 | Wall Elbow With Holder Combo**

**SPECIFICATIONS:**

- Solid Brass construction
- Includes check valve with back flow prevention.

**FAST SHIP FINISHES :**

- Chrome - HS8008CP / Brushed Nickel - HS8008BN

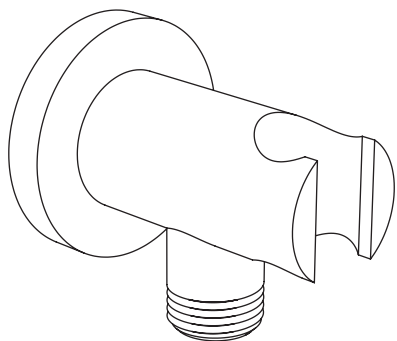

**Technical Diagram**

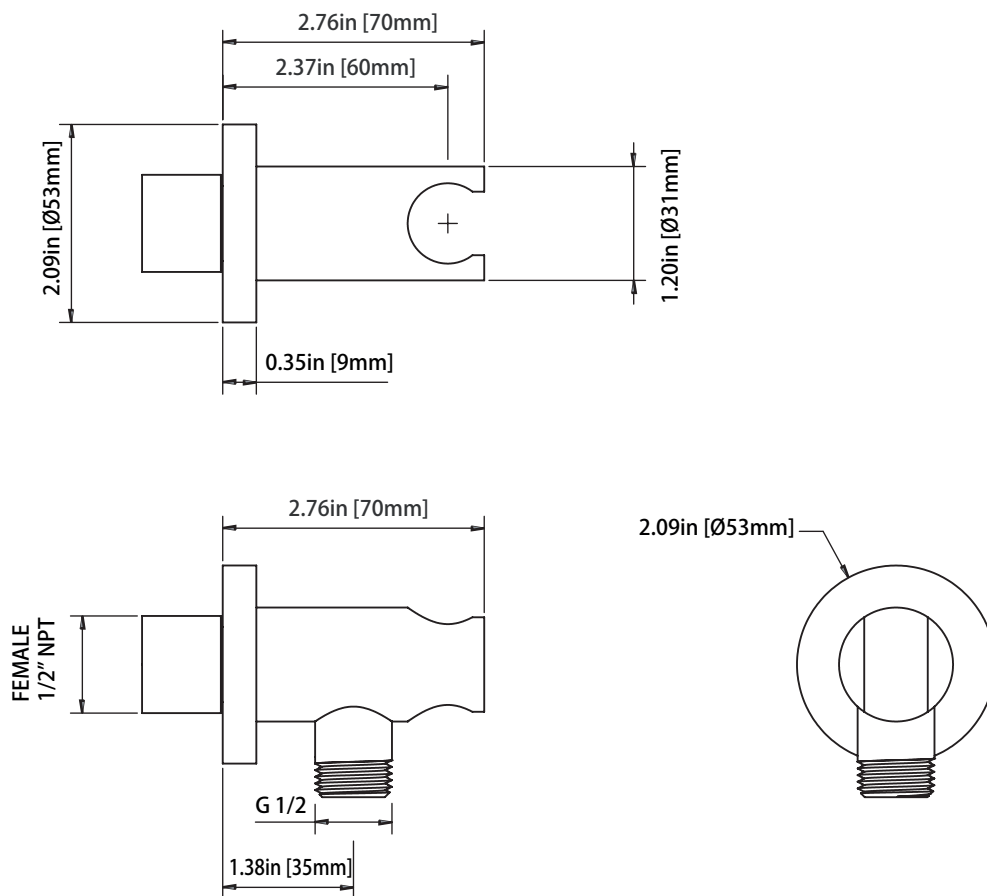

SP.150EM | Easy Maneuver Hose



SPECIFICATIONS:

- Stainless steel construction
- G-1/2" connection
- 1.5m length

Technical Diagram

