

# Product Parts Breakdown

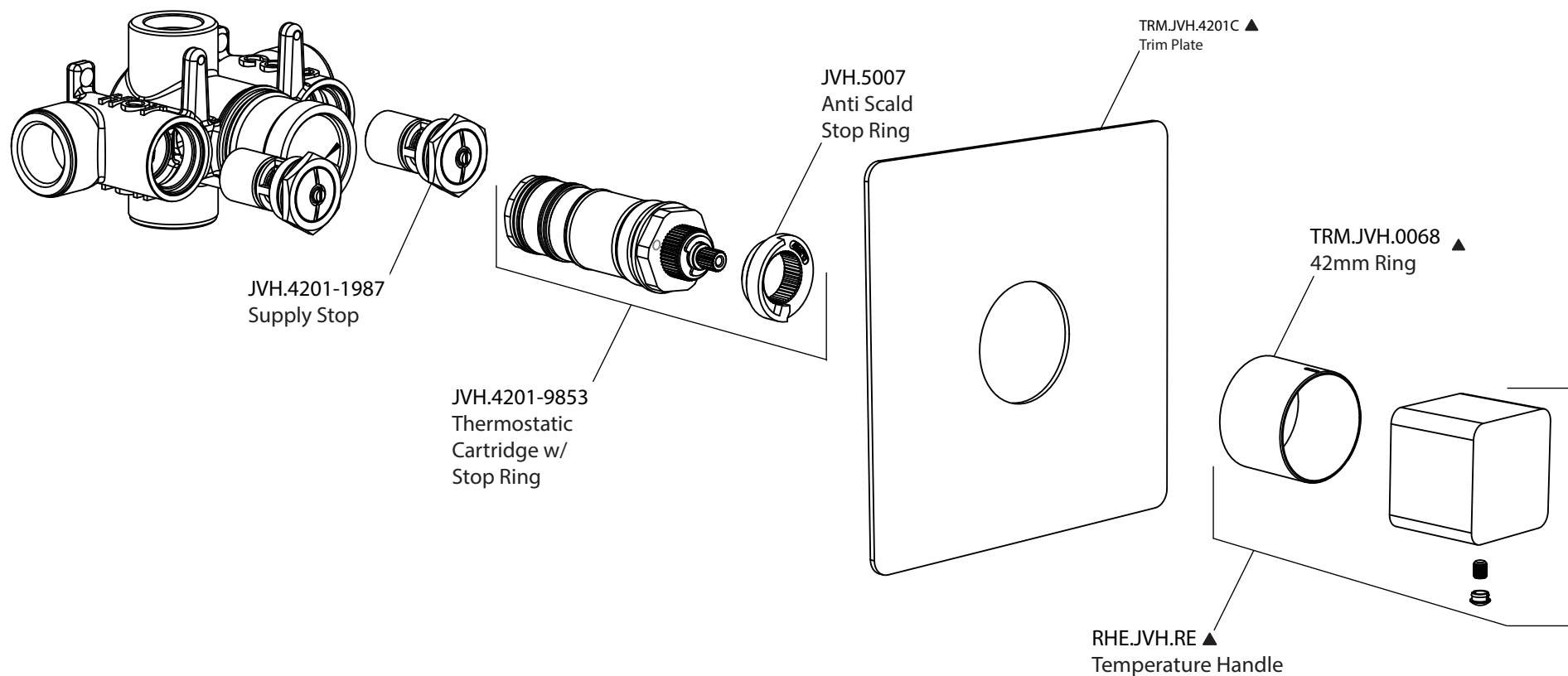

**Model No.**RHE.4201

**Ver** 2.53