

Product Parts Breakdown

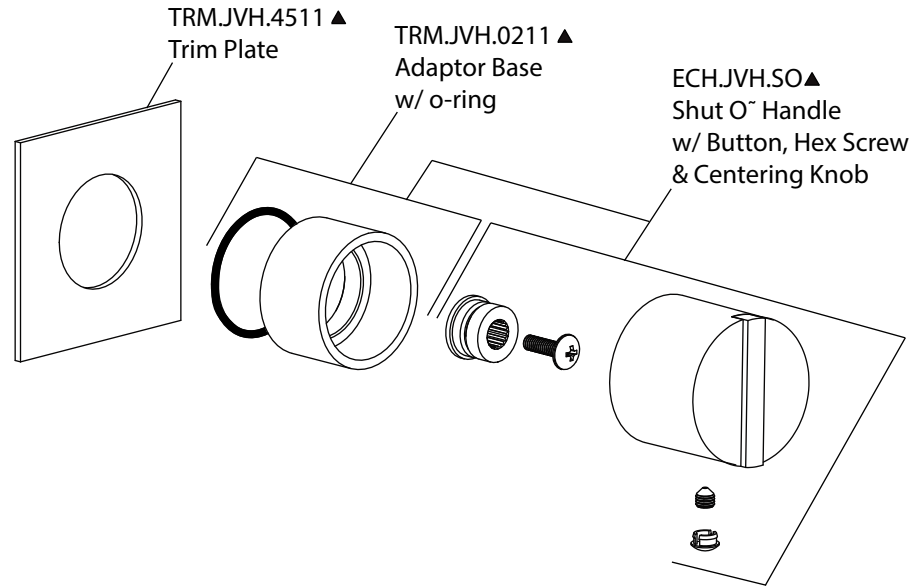

Model No.ECH.4511T

Ver 2.53