

Product Parts Breakdown

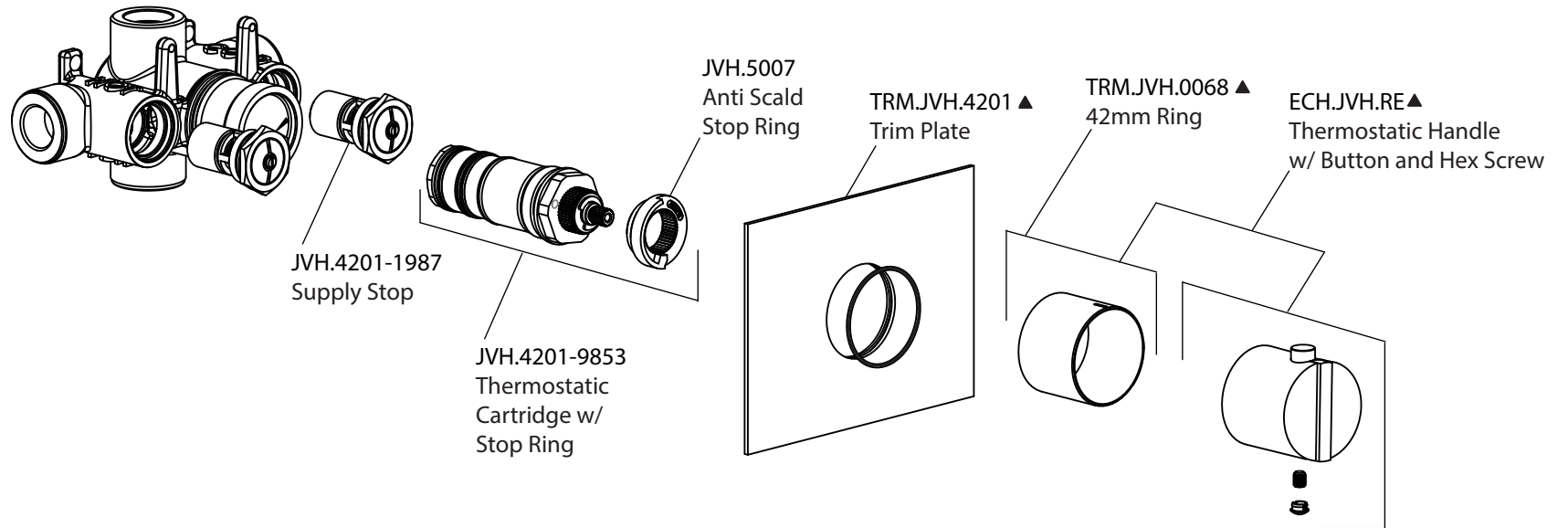

Model No.ECH.4201

Ver 2.53