

Installation Manual For 150.1280

Deck Diverter Trim With Hand Shower

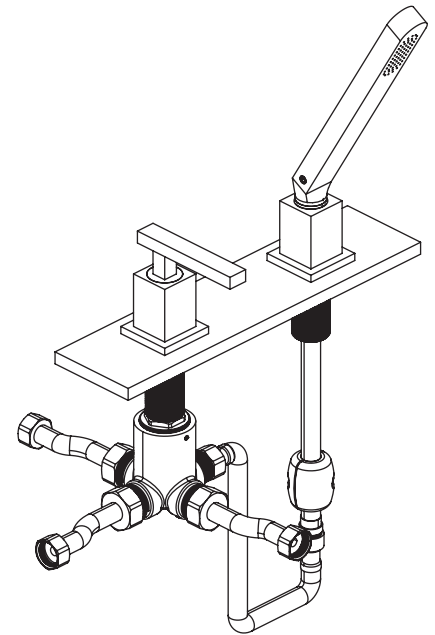

** Deck Diverter Valve Sold Separately*

NOTICE TO HOMEOWNER

- We recommend that this product is installed by a qualified professional plumber.
- Please check this product immediately to ensure that it has not been damaged and is complete. Before installation, please make sure this product is the correct model and you have all the parts required for installation and use.
- Please flush the water system to ensure that no metal swarf, solder, and other impurities can enter the product.
- Turn off water supply before commencing work.
- Please read these instructions carefully and retain for future reference.

BEFORE YOU BEGIN

- You must observe all local plumbing laws and codes.
- Do not install this valve if it does not meet local plumbing codes.
- Shut off the main water supply.

Installation Manual For 150.1280

Deck Diverter Trim With Hand Shower

TABLE OF CONTENTS

• OPERATING SPECIFICATIONS	1
• INSTALLING THE HAND HELD & HOSES	2
• INSTALLING THE DECK DIVERTER AND TRIM	3
• HOSE INSTALLATION	7
• CARTRIDGE REPLACEMENT	7

OPERATING SPECIFICATIONS

WATER TEMPERATURE



This product is to be used with water at a temperature range of 40°F - 120°F ONLY!

WATER PRESSURE



This product is to be used with a water pressure range of 15 PSI to 80 PSI ONLY

If water pressure is greater than 80 PSI install a pressure reducing valve (PRV)

This valve meets or exceeds ANSI A112.18.1 and ASSE 1016

INSTALLING THE HAND HELD & HOSE

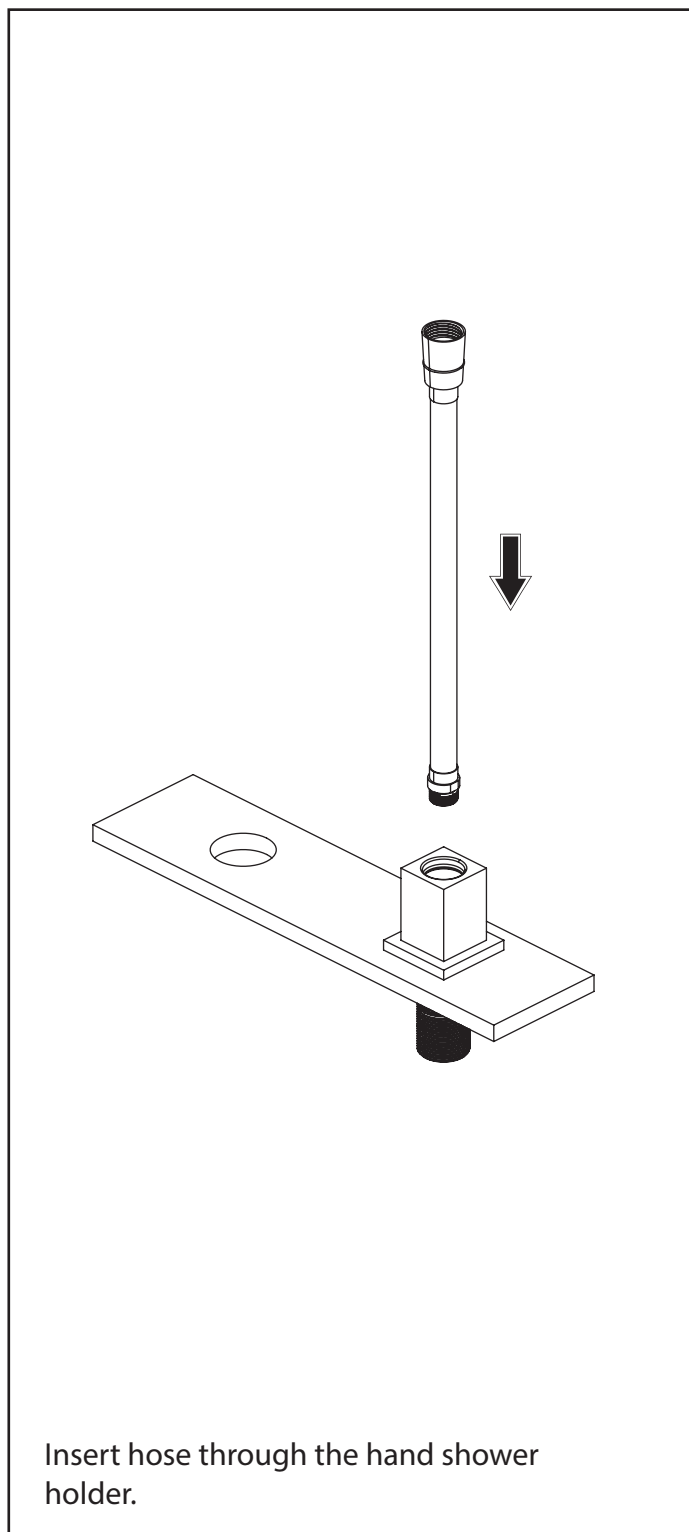
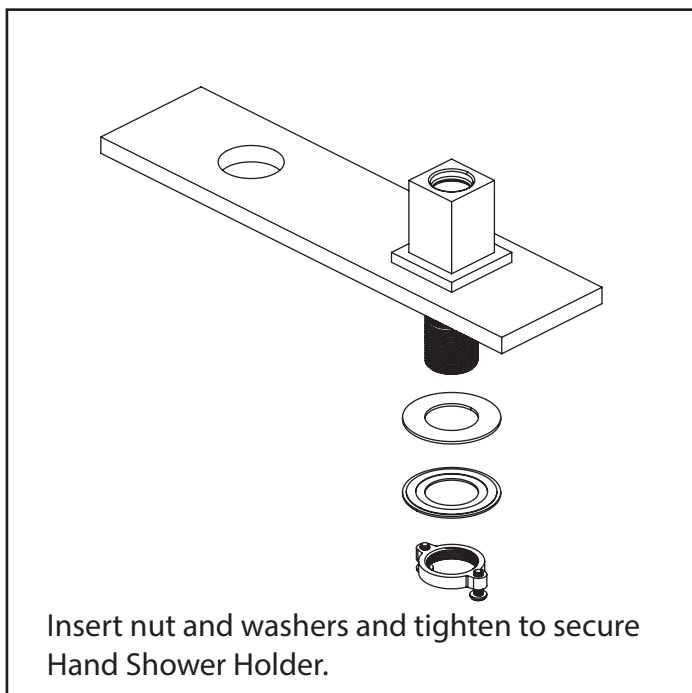

INSTALLING THE HAND HELD & HOSE

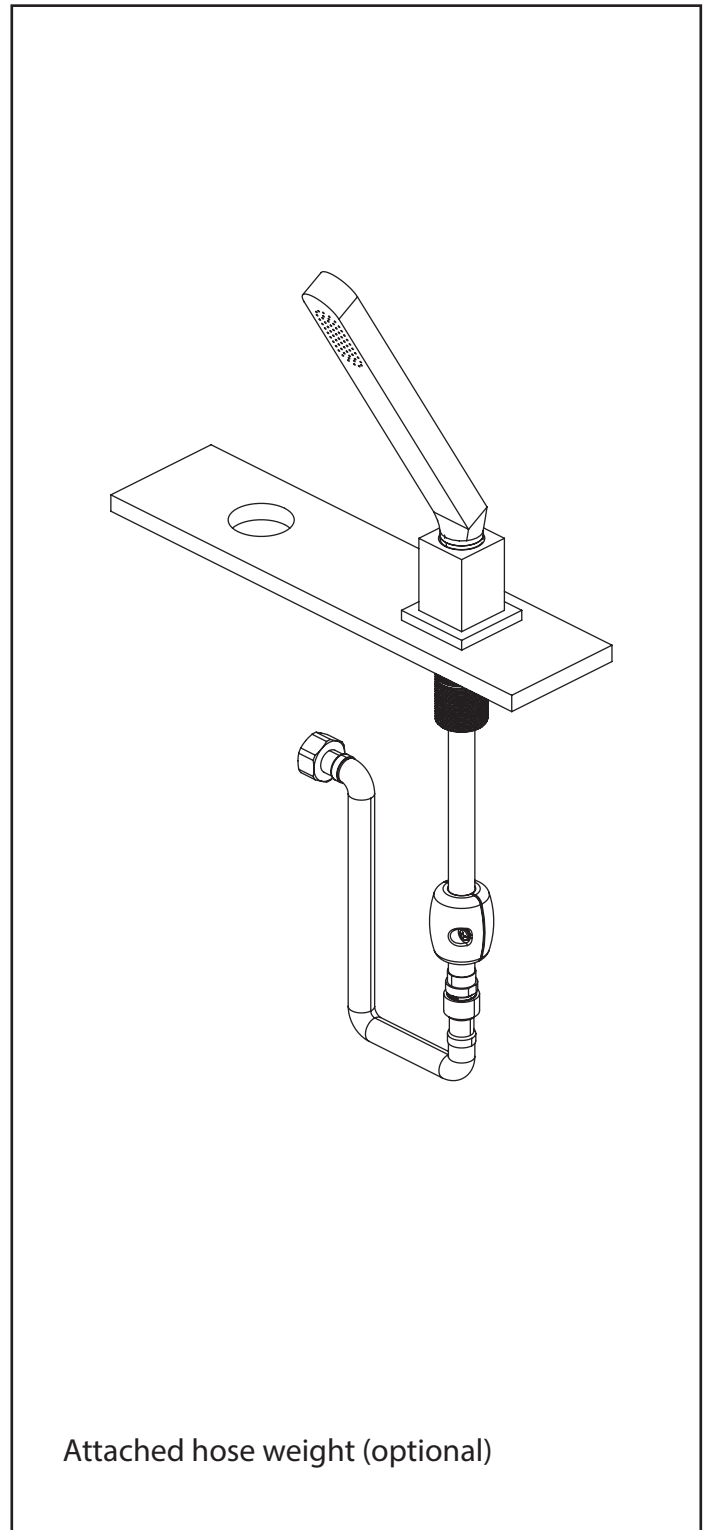
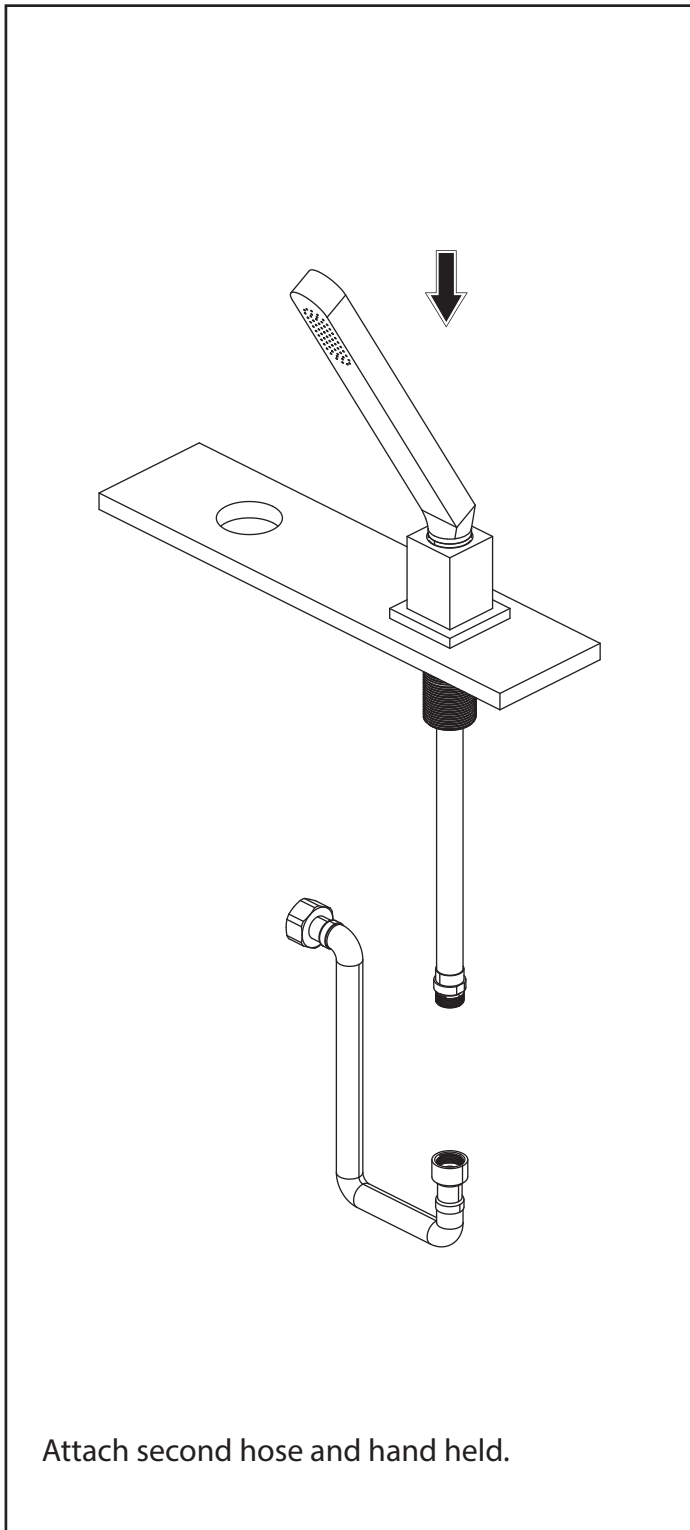

INSTALLING THE DECK DIVERTER AND TRIM

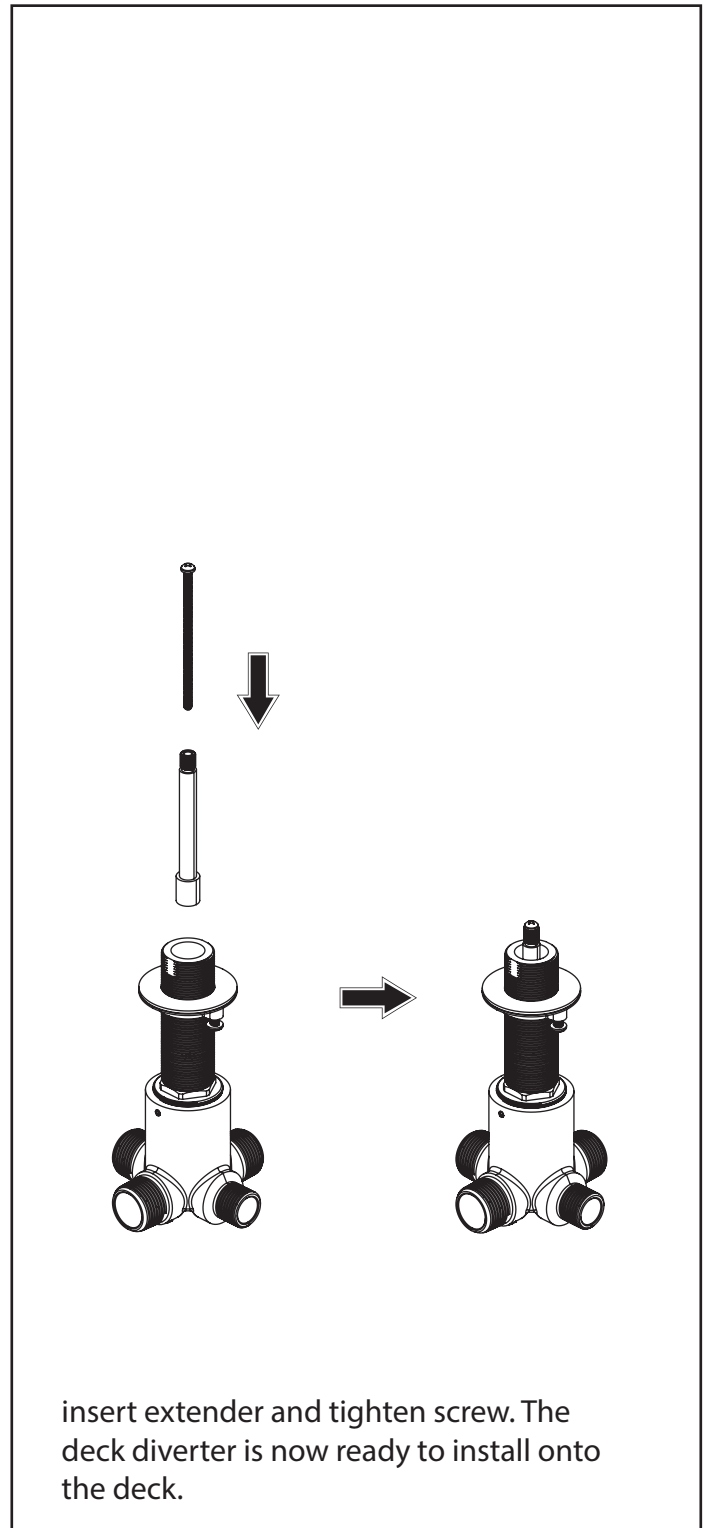
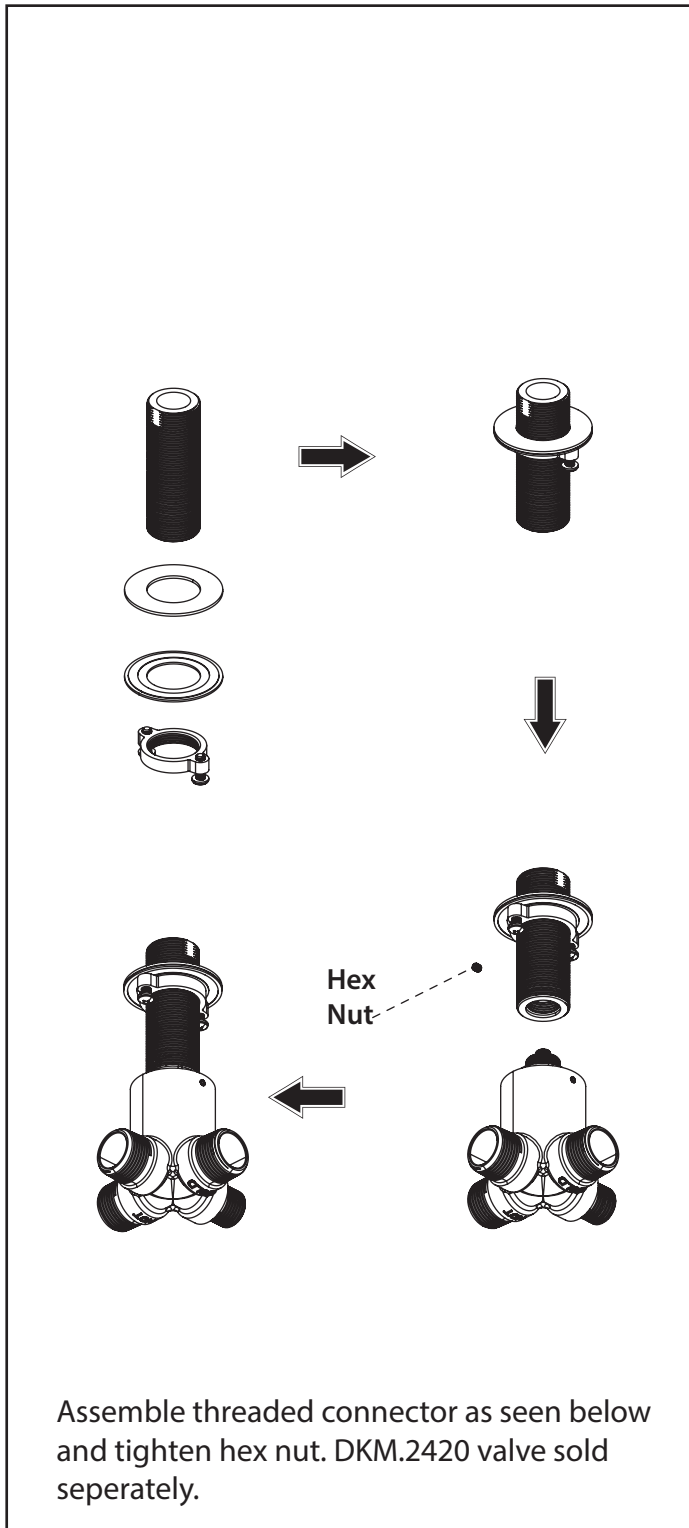

INSTALLING THE DECK DIVERTER AND TRIM

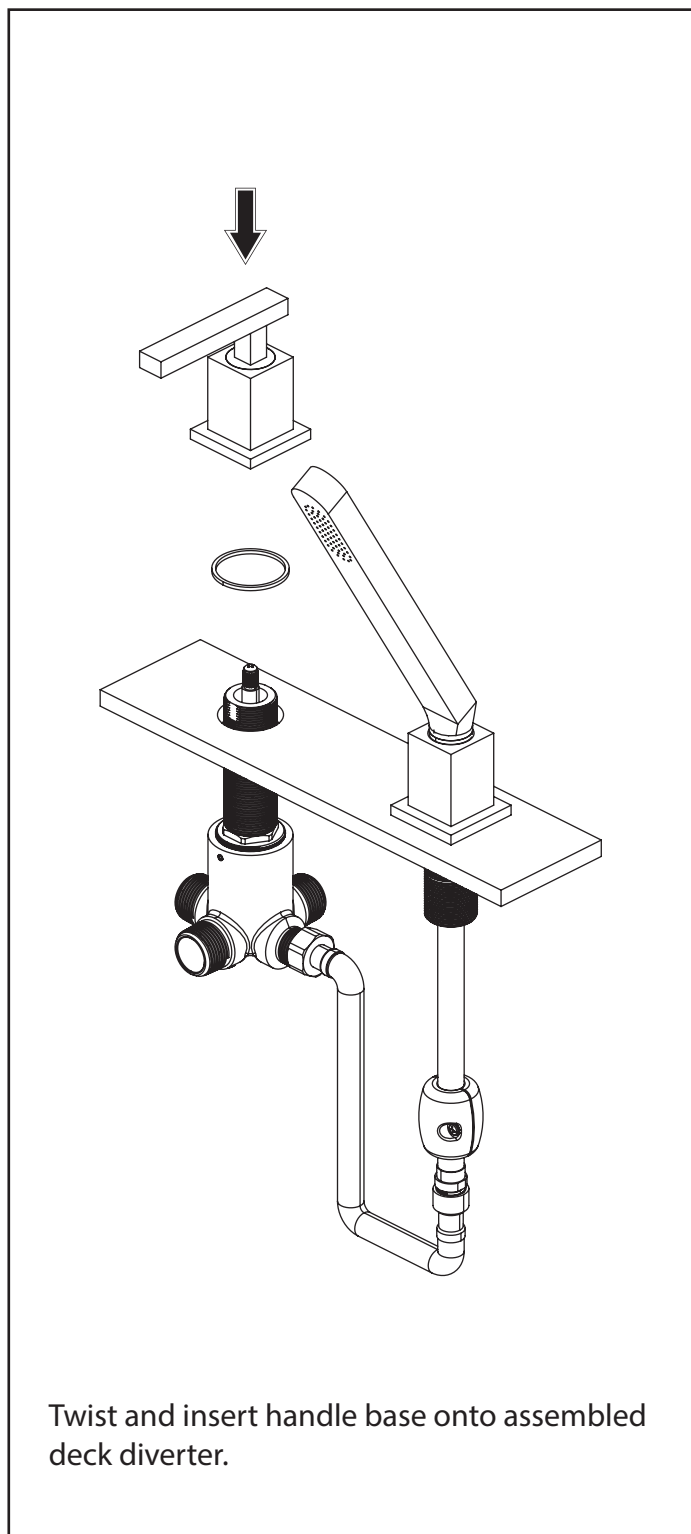
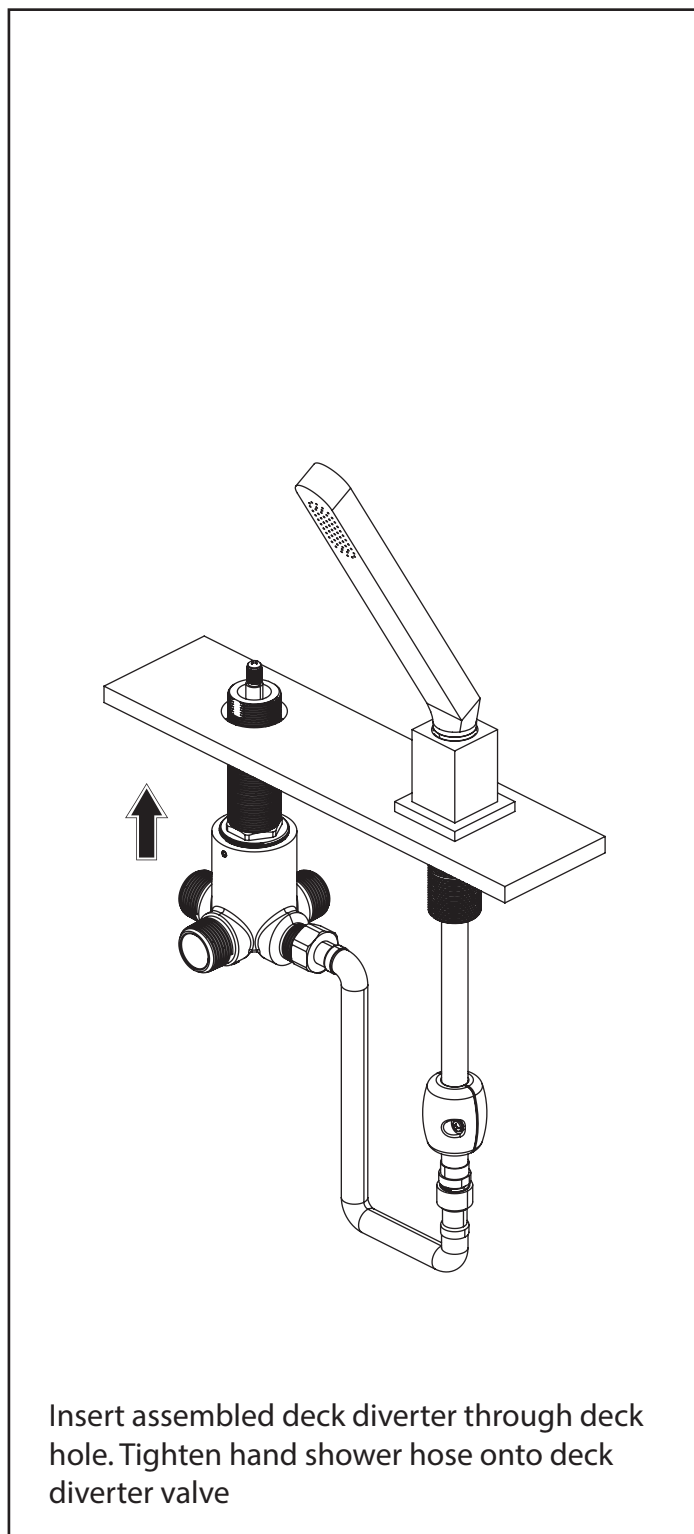

INSTALLING THE DECK DIVERTER AND TRIM

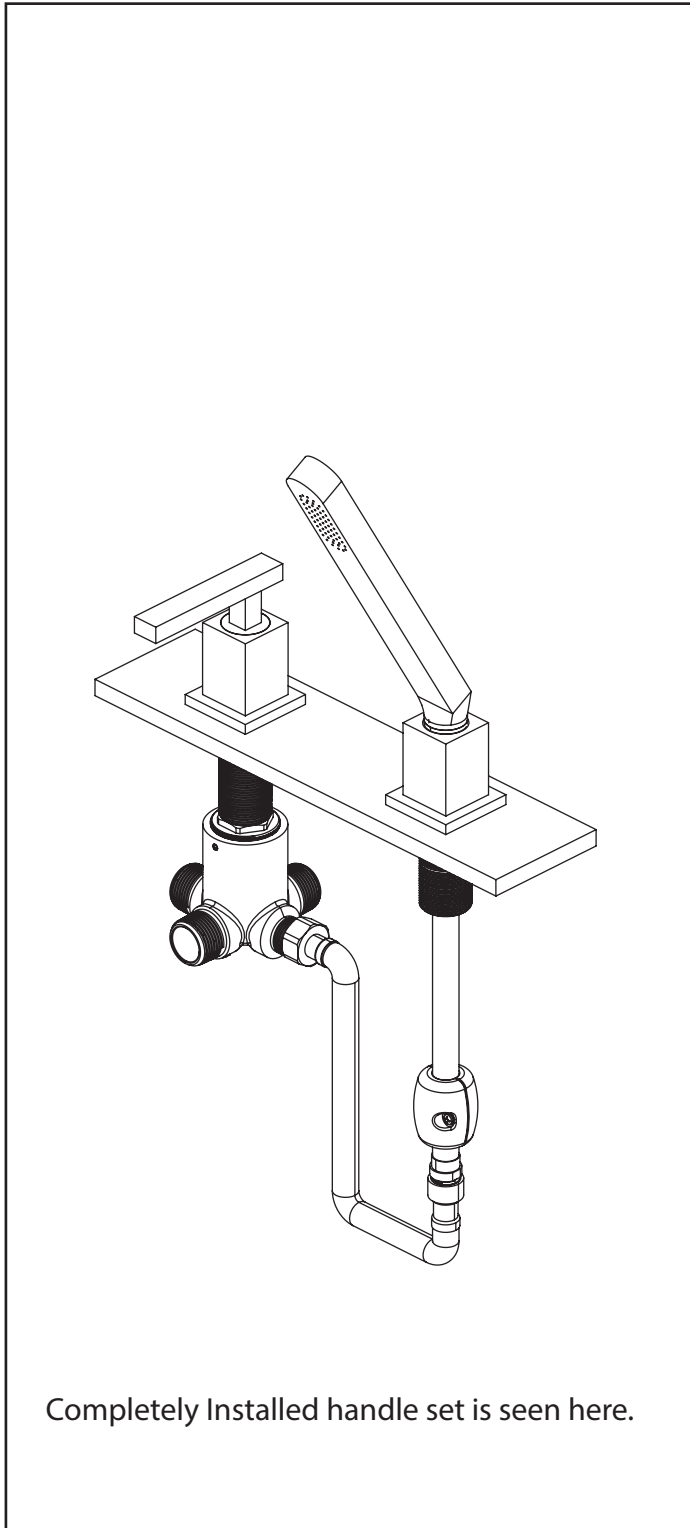

HOSE INSTALLATION

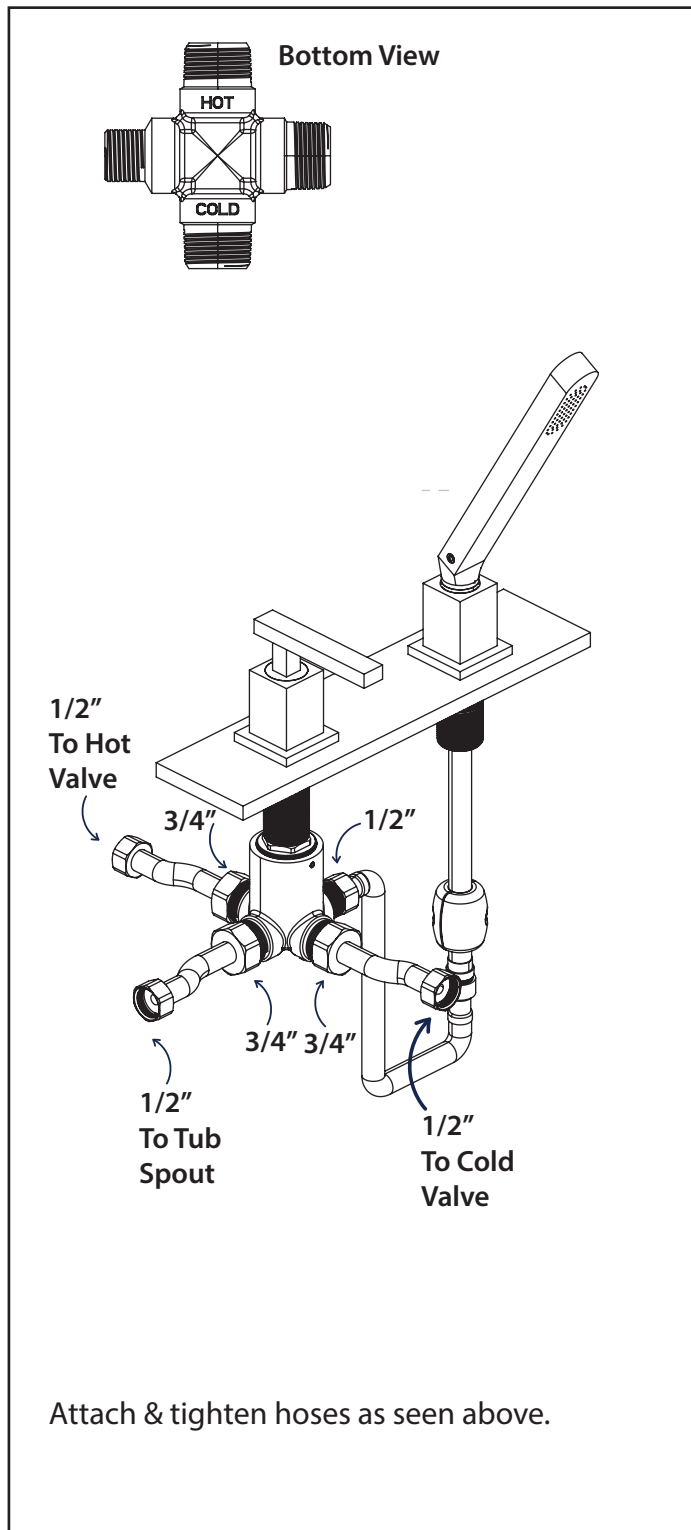

CARTRIDGE REPLACEMENT

